

Difuzor elicoidal circular cu lamele fixe

CWA-2



Detalii constructive. Utilizare.

Difuzor elicoidal circular (swirl diffuser) cu 24 lamele fixe dispuse radial, curbate.

Designul special asigura o pierdere de presiune statica mica si un nivel de zgomot scazut.

Utilizate pentru refulare, aspiratie sau recirculare aer, in sisteme de ventilatie si aer conditionat.

Material.

Placa circulara din otel.

Finisaj.

Finisaj standard: alb RAL9003.

Finisaje optionale:

- diverse nuante RAL (cost suplimentar)

Montaj. Fixare.

Montaj pe plafon (in interior).

Se monteaza in plafon continuu.

Sistem de fixare in plenumul de racord cu brida de fixare **BW**.

Accesorii optionale.

Plenum racord (adaptor tubulatura) – **PSW** (cost suplimentar).

Sisteme de fixare.

Cod comanda: CWA-2 595 + *

Cod produs
dimensiune

nespecificat - alb RAL9003 (standard)
RALxxxx - cod RAL optional

* accesorii optionale

Date tehnice

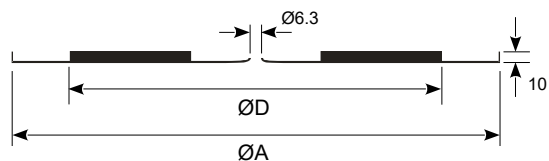
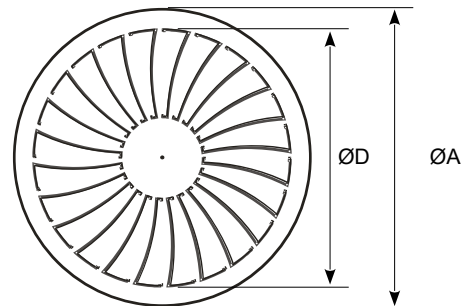

Dimensiuni

Dimensiuni	nr. lamele	ØA	ØD
625	24	625	560
595	24	595	530
500	24	500	430
400	24	400	340
300	24	300	240

Nu sunt disponibile alte dimensiuni.

Difuzor elicoidal circular cu lamele fixe

CWA-2

Date tehnice

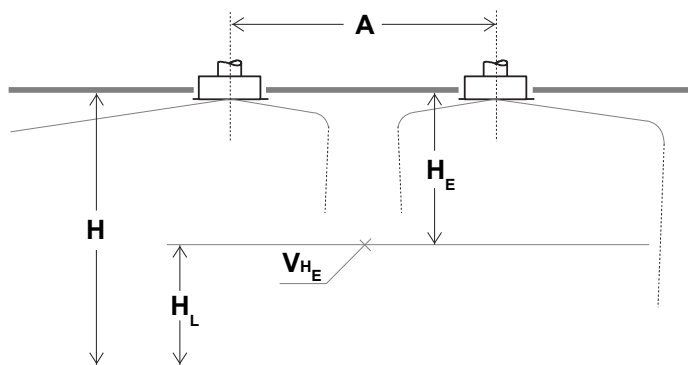

- $H = 2,5\text{--}4,0$ m (inaltime incapere)
- $H_L = 1,8$ m (zona ocupata)
- $H_E = H - H_L$ (m)
- A = distanta amplasare SWR (m)
- V_{H_E} = viteza aer la intrare in zona H_L (m/s)

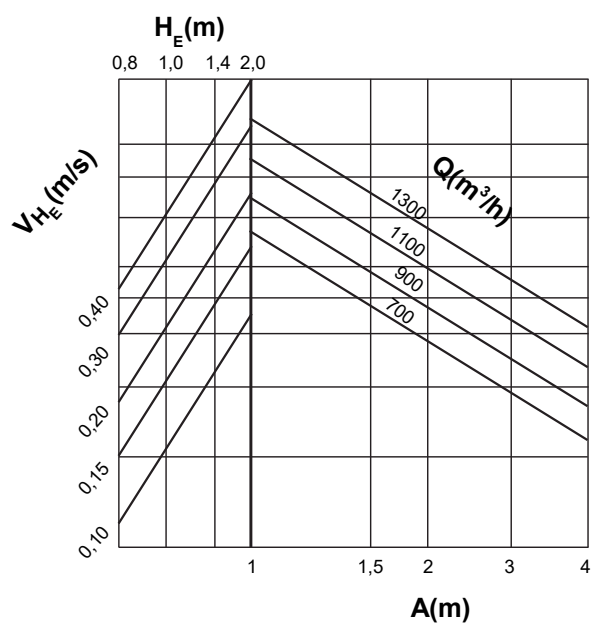
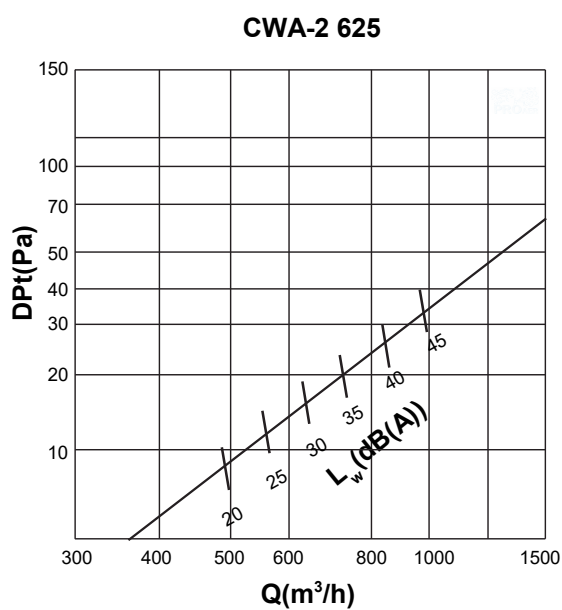

Difuzor elicoidal circular cu lamele fixe

CWA-2

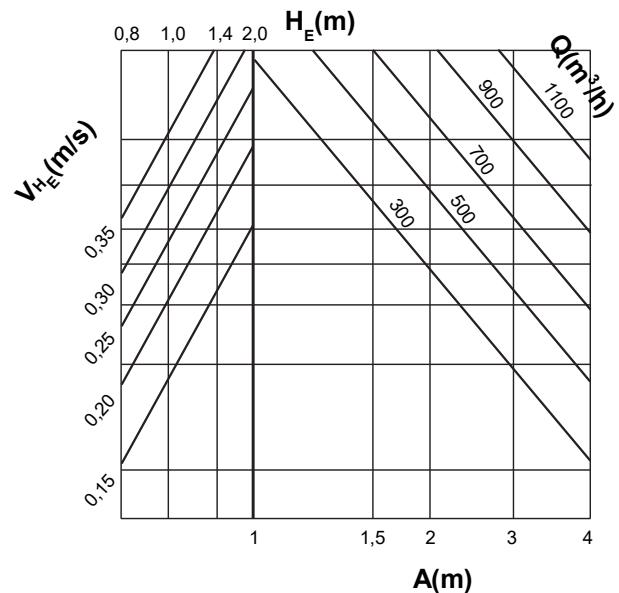
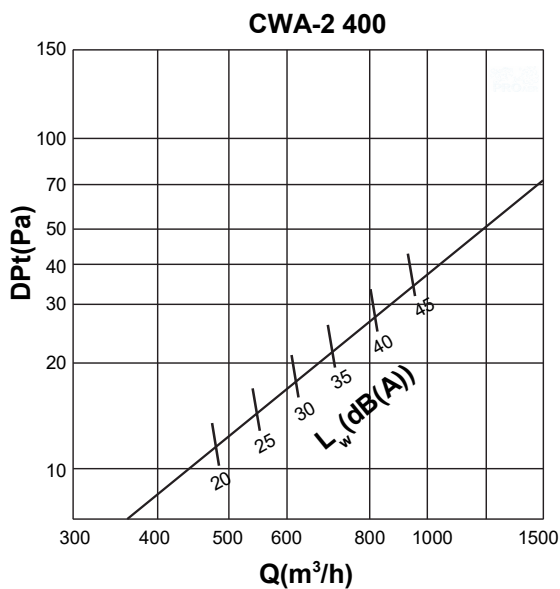
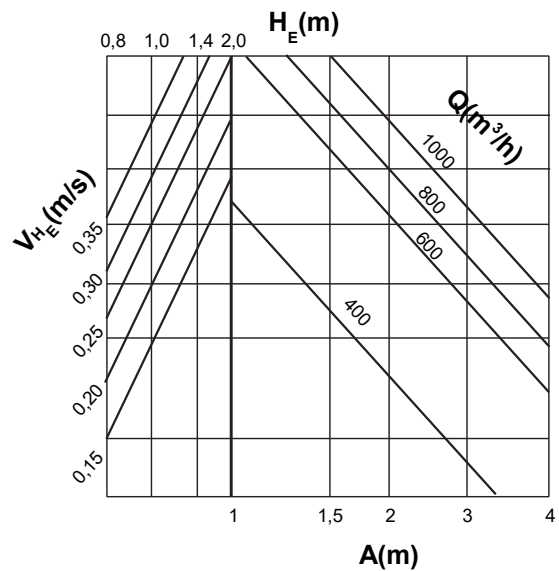
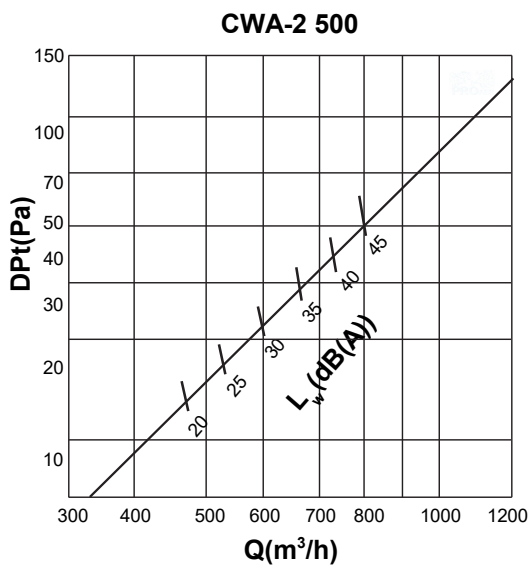
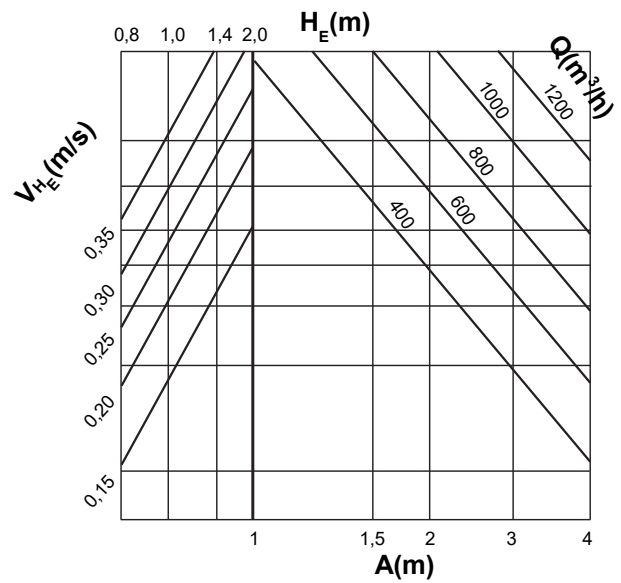
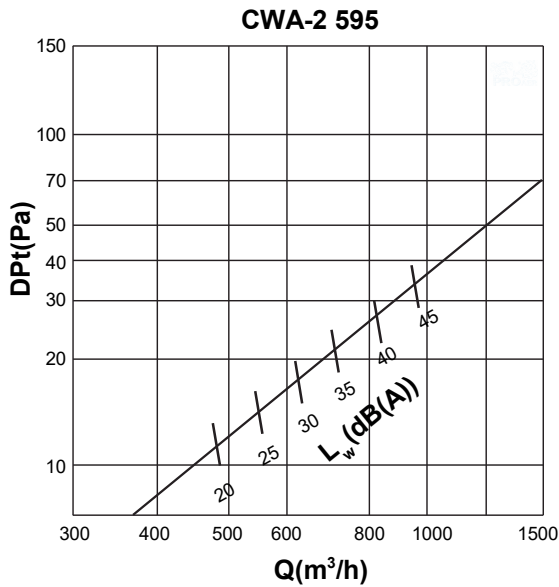

Difuzor elicoidal circular cu lamele fixe

CWA-2

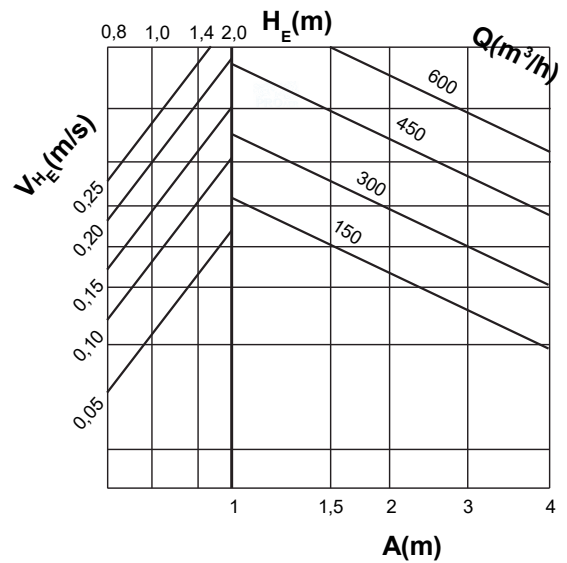
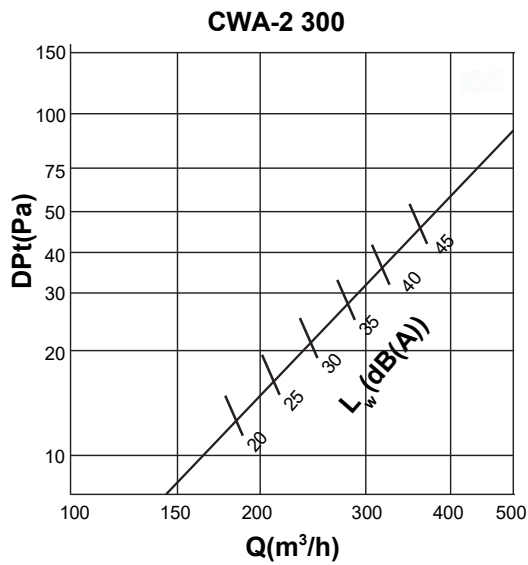

Montaj

Nota: Plenum-ul de racord **PSW** si brida de fixare **BW** nu sunt incluse (cost suplimentar)
Chiar in cazul in care plenumul de racord se furnizeaza impreuna cu difuzorul elicoidal,
brida de fixare **NU** se livreaza montata in plenum. Acest lucru se face pe santier.

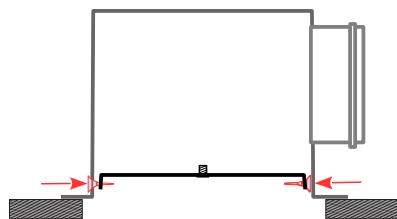

1. Ajustati si fixati brida **BW** in plenum

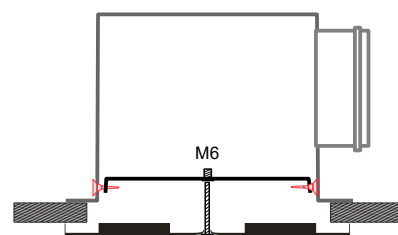

2. Fixati difuzorul elicoidal prin insurubare (surub M6x80) si aplicati dopul de mascare.

Brida de fixare **BW**

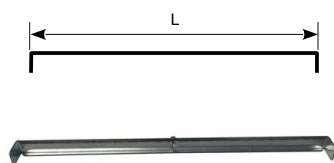

Brida de fixare **BW**

CWA-2	L
625	580
595	550
500	450
400	360
300	260