

Square swirl diffuser with fixed blades

SWA-2



Specifications

Square swirl diffuser with 24 radial fixed blades.

Used for supply, exhaust or recirculation in ventilation systems.

Material

Steel plate.

Finish

Standard finish: white RAL9003.
Optional finishing: different RAL (extra cost).

Mounting / Fixing

Mounting on standard or cassette ceiling (inside).

Fixing in plenum box with crossbar **BW** (extra cost).

Optional accessories

Plenum box – **PL** (extra cost).
Fixing systems.

Order code: **SWA-2** **595** + *

Product code
size

not specified - white RAL9003 (standard)
RALxxxx - optional RAL code

* optional accessories

Technical data

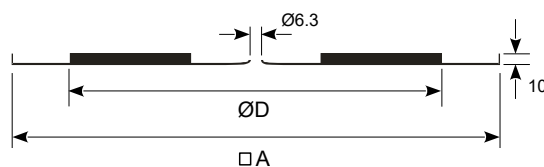
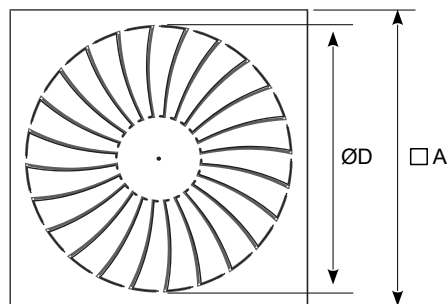

Standard sizes

Dimensions	no. of blades	□A	ØD
625	24	620	560
595*	24	595	530
500	24	498	430
400	24	398	340
300	24	298	240

*external size AxB 595x595 for cassette ceiling system.

There are no other sizes available.

Square swirl diffuser with fixed blades

SWA-2

Technical data

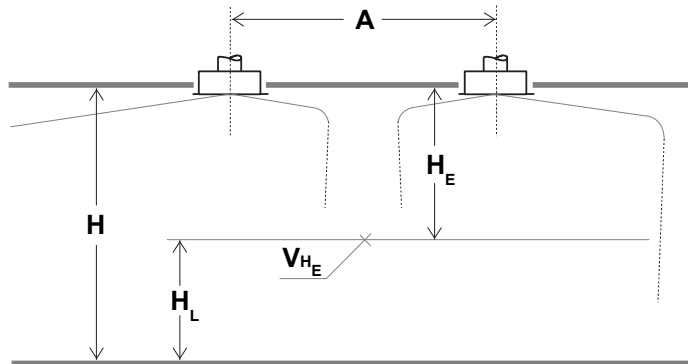

$H = 2,5\sim 4,0$ m (room height)
 $H_L = 1,8$ m (occupied area)
 $H_E = H - H_L$ (m)
 $A =$ distance (m)
 $V_{H_E} =$ air velocity when entering in zone H_L (m/s)

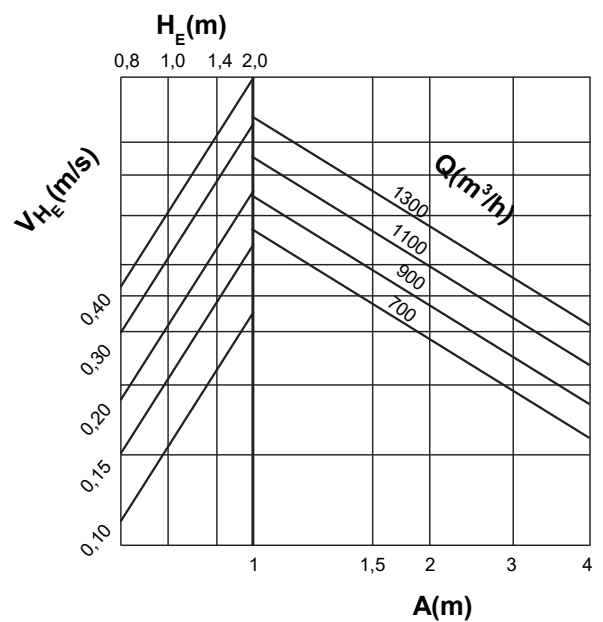
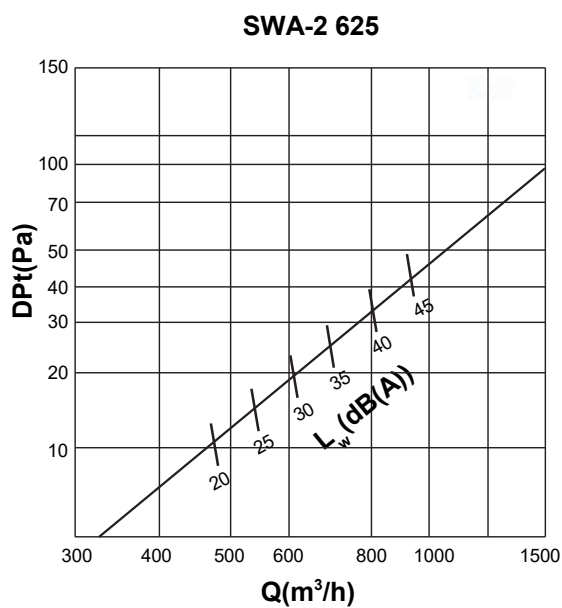

Square swirl diffuser with fixed blades

SWA-2

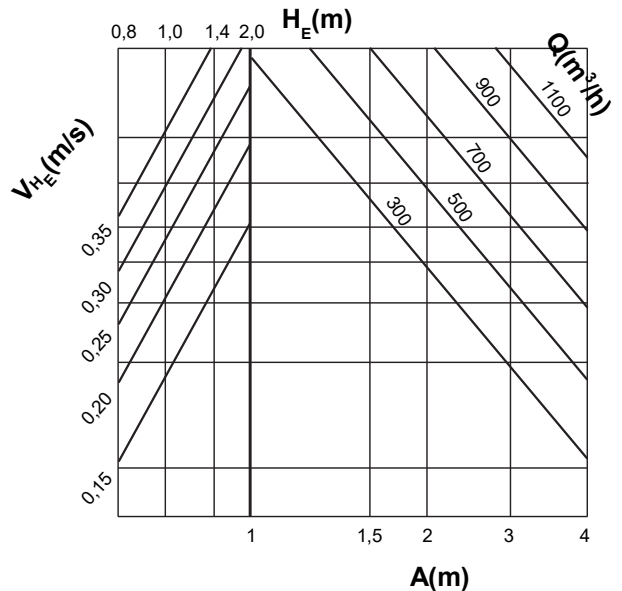
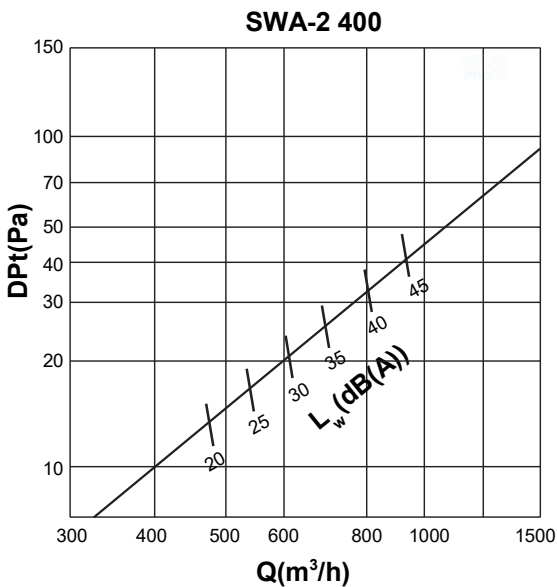
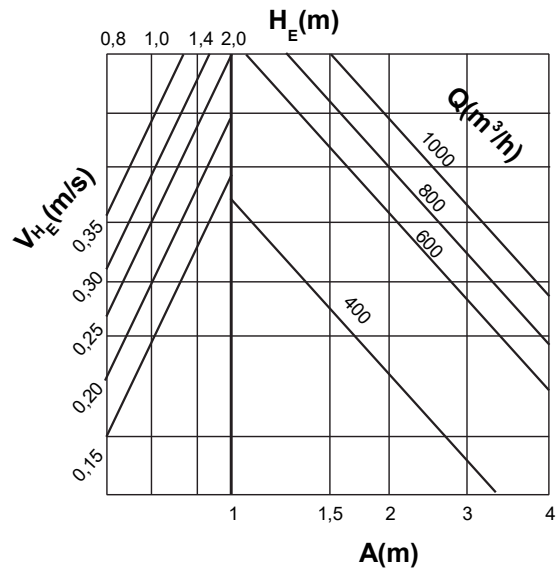
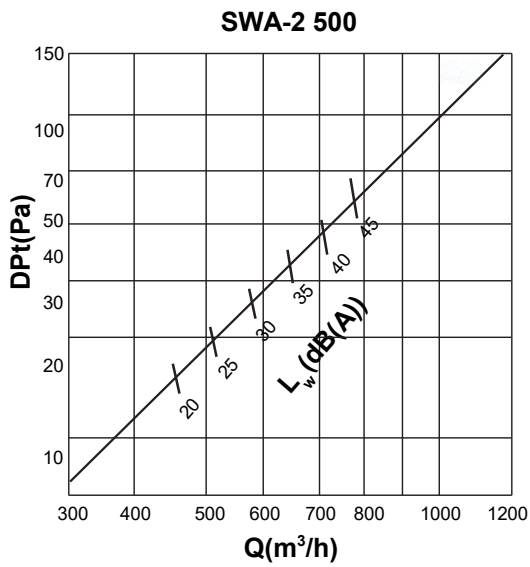
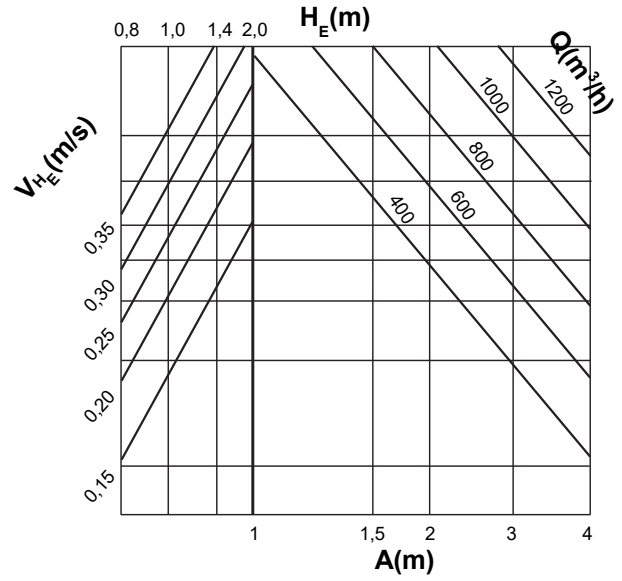
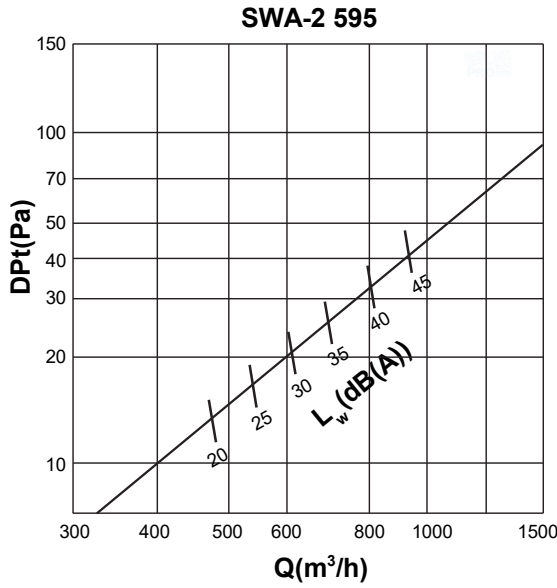

Square swirl diffuser with fixed blades

SWA-2

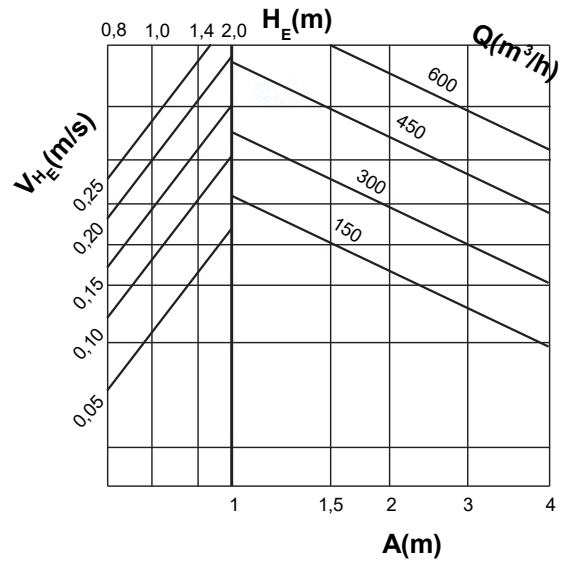
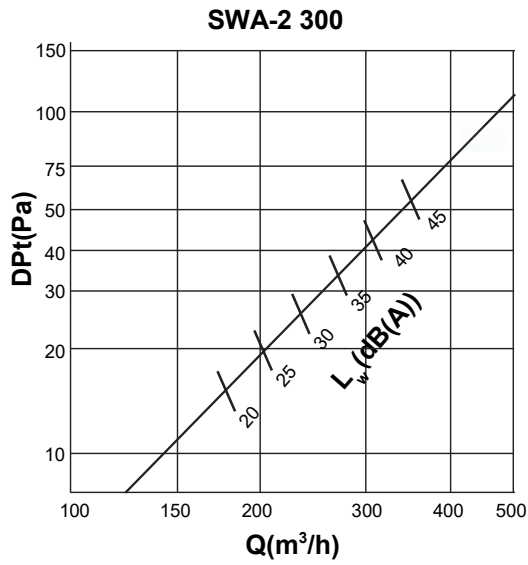

Mounting

Note: Plenum box **PL** and crossbar **BW** are not included (extra cost).
The crossbars are not delivered mounted in plenum box.

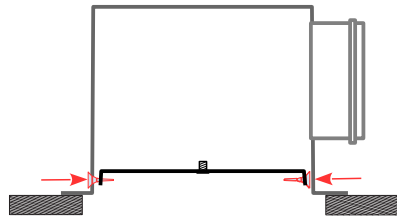

1. Adjust and mount the crossbar **BW** into the plenum box

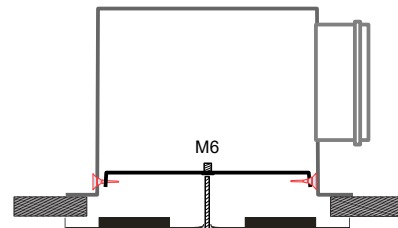

2. Attach the diffuser with M6x80 screw to the crossbar

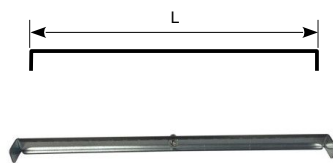

Crossbar **BW**

SWA-2	L
625	580
595	550
500	450
400	360
300	260