



# SOLAR

PREMIUM QUALITY

**NON-PRESSURIZED SOLAR WATER HEATER**

---

**CUSTOMER USER INSTALLATION MANUAL**



JNG series

(Version 1.1 - July 2018)



## Warning!

For your safety, please read through this manual carefully before installation to minimize the risk of fire, property damage, and personal injury!

### SAFETY PRECAUTIONS

#### 1. METALLIC COMPONENTS

Always wear leather protective gloves when handling solar heater components. All efforts have been made to make the metal components safe to handle, but there may still be some sharp edges.

#### 2. VACUUM TUBES

- a) Be careful when handling the vacuum tubes, as they will break if knocked heavily or dropped.
- b) If exposed to sunlight and therefore hot (have internal pressure built up), the tubes may explode rather than implode if knocked and broken. This is a rare occurrence, but nevertheless safety precautions should be taken.
- c) If the vacuum tubes are struck by a hard object with sufficient force (ie. branch falling on roof), they may break. During installation consideration should be taken as to the possible path any broken glass may take. Where possible protection should be implemented to prevent broken glass from reaching ground level where somebody could walk on it (ie. Guttering on roof).
- d) The home owner should be made aware by the Installer the location of the solar system and the possible vicinity of broken glass in the event of an extreme storm or object falling on the collector.

#### 3. HEALTH & SAFETY

- a) Always wear safety glasses when handling vacuum tubes.
- b) Adhere to safety regulations regarding working on roofs (or at a height).
- c) Always obtain engineer approval for installations in high wind regions.

#### 4. TRANSPORTATION

Safety is critical during lifting. Appropriate equipment must be used. Full safety and arrest training is essential. For hand lifting, assemblies and parts are lifted piece by piece to the elevated mounting location. The frame assembly is normally lifted first. Firmly anchor the frame. Then the tank is lifted and placed on the shoulder rests, and bolted down.

#### 5. SNOW AND ICE LOAD

In region, where is rich of snow in winter, man should note the regulation of local construction bureau about the collector installation angle of inclination roof. Considering stacking of snow, moving of snow by wind and freezing of snow, the load of snow will increase, so it is necessary to take measure to avoid this situation happening.

#### ***Before you start***

The assembly of the solar water heater requires two able persons with the ability to lift 30Kg each.

Best to install on cool and cloudy day.

Store vacuum tubes in dark or shaded place until insertion into the tank.



















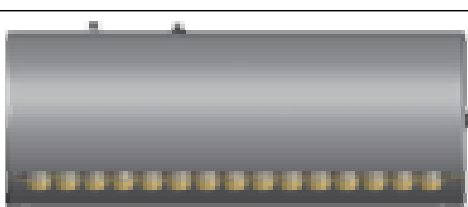

#### ***Things you need***

14mm ratchet

Adjustable wrench

Liquid soap or other non-flammable lubricant.

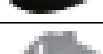
Parts list of solar water heater

A1		A2	
B1			
B2			
C1			
C2			
D			
E			
F			
G			
H			
I			
J			
K		L	
M			
N		O	
P		Q	

## Assembly Manual

Solar water heater consists of glass vacuum tubes, water main tank, and frame.

The frame and all fastenings are contained in a long thin carton. Please unpack this carton with care and lay out the parts, being careful not to lose any of the smaller fittings.

Use the pictures below to help identify the parts needed for each stage of the assembly.

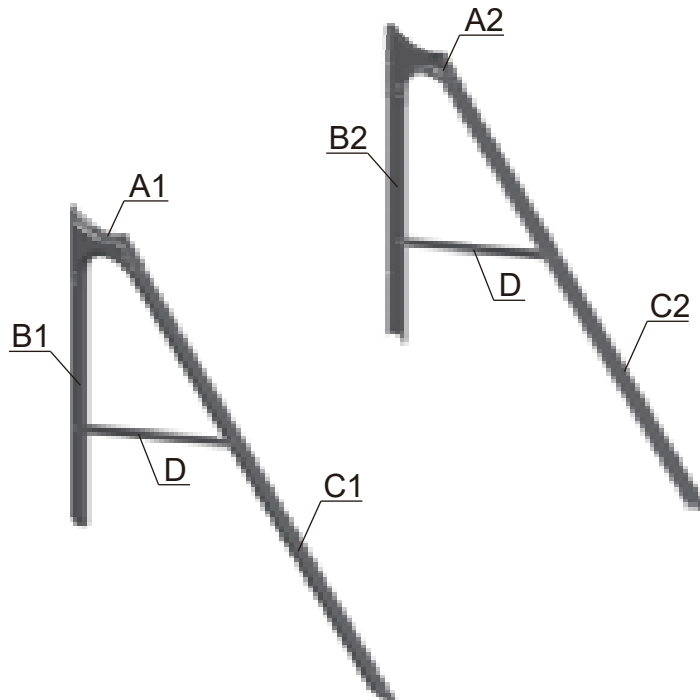

1. Install the front legs(C) rear legs(B) side drawbar(D) and tank support(A), tighten the nuts between front legs(C1, C2) rear legs(B1, B2) side drawbar(D) and tank support(A).

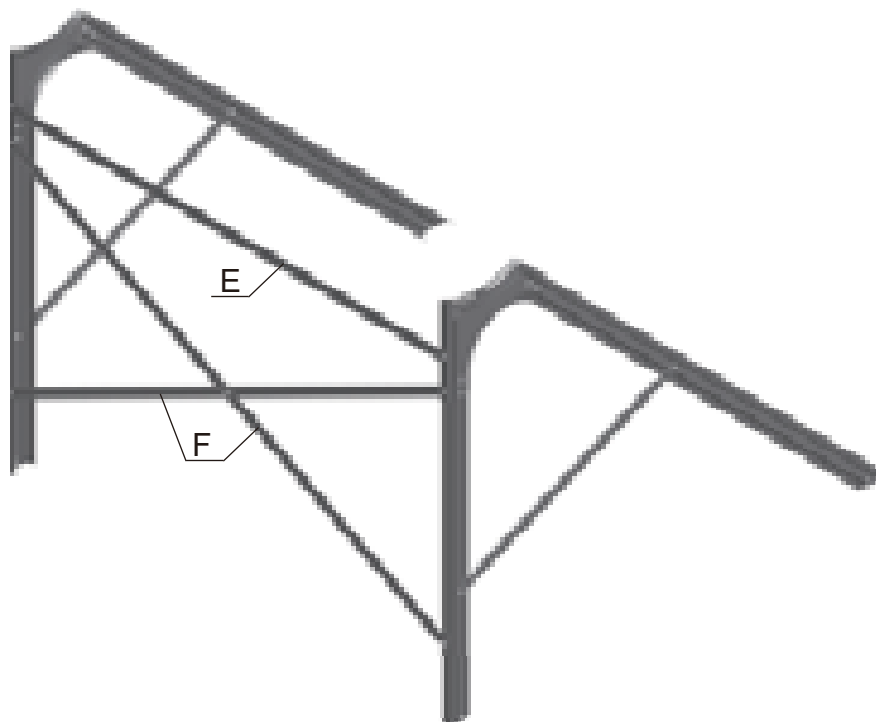

2. Install horizontal bar (F) and cross bars(E) between the rear legs(B1, B2) to creat "X".

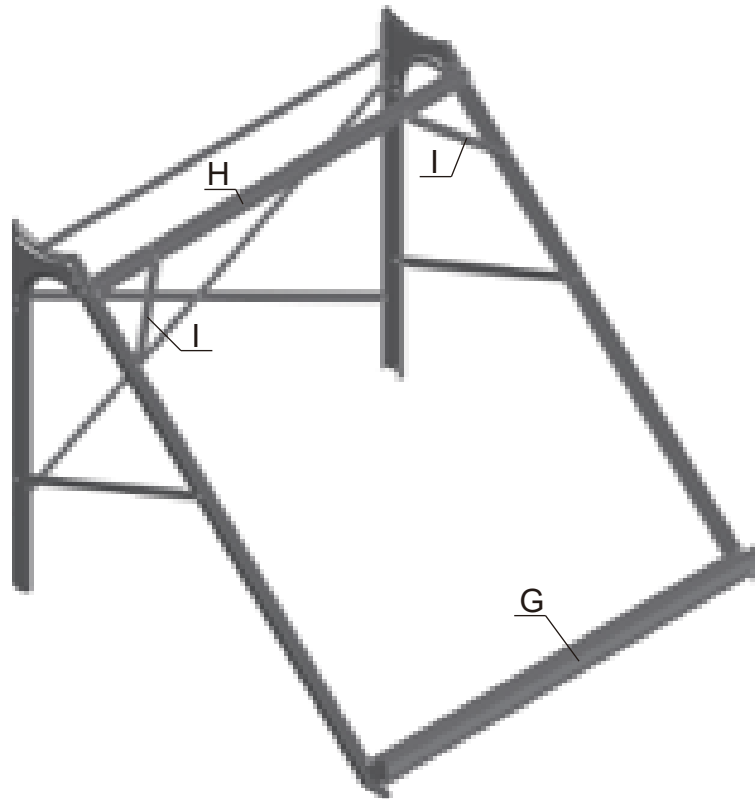

3. Install the tail stock(G) on the front legs(C1, C2), tighten nuts.
4. Install the horizontal bar(H), tighten the nuts between front legs(C1, C2) and horizontal bar(H).
5. Install oblique bars(I) between the front legs(C1, C2) and horizontal bar(H).

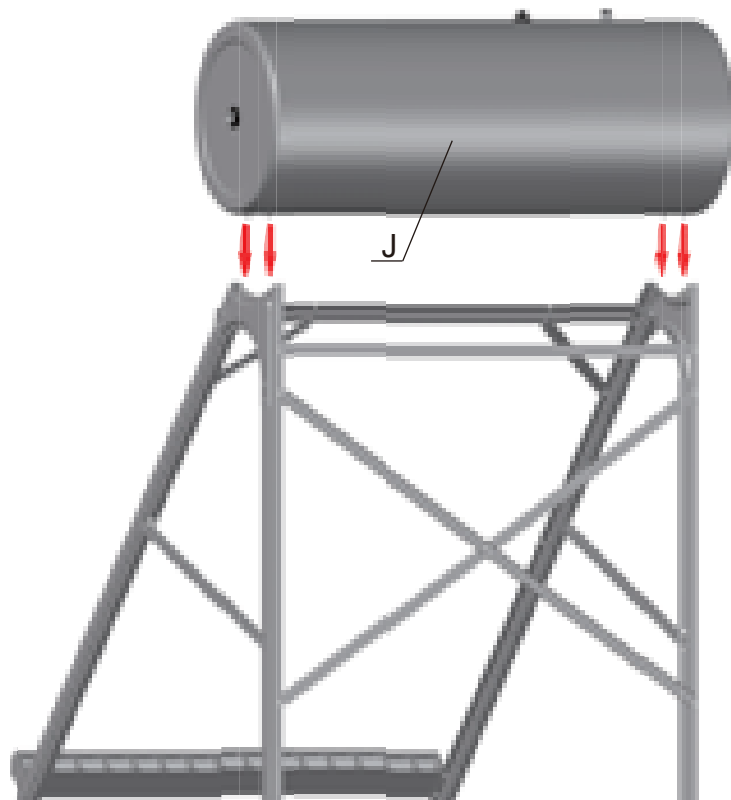

6. Unscrew the nuts of solar water tank(J), then place the tank on the top of tank bracket(A1, A2), and tighten nuts.

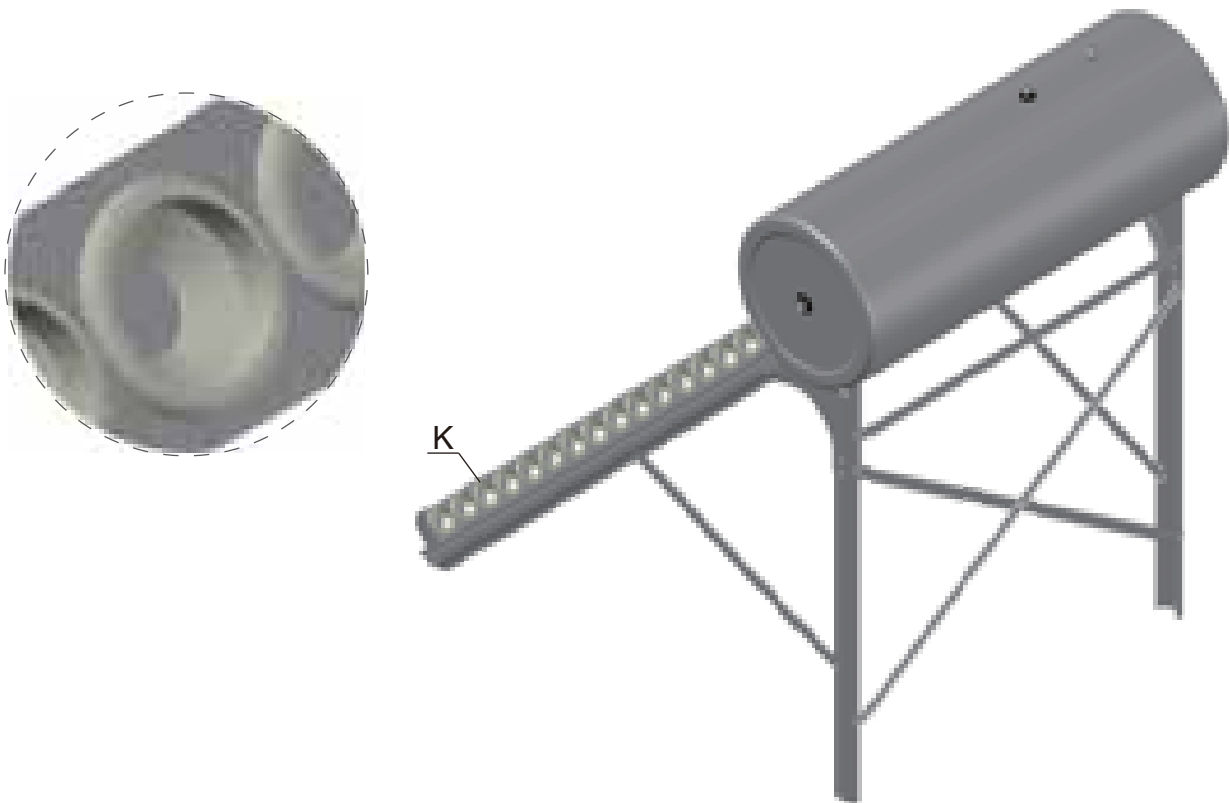

7. Put tube caps (K) into tailstock holes (G).

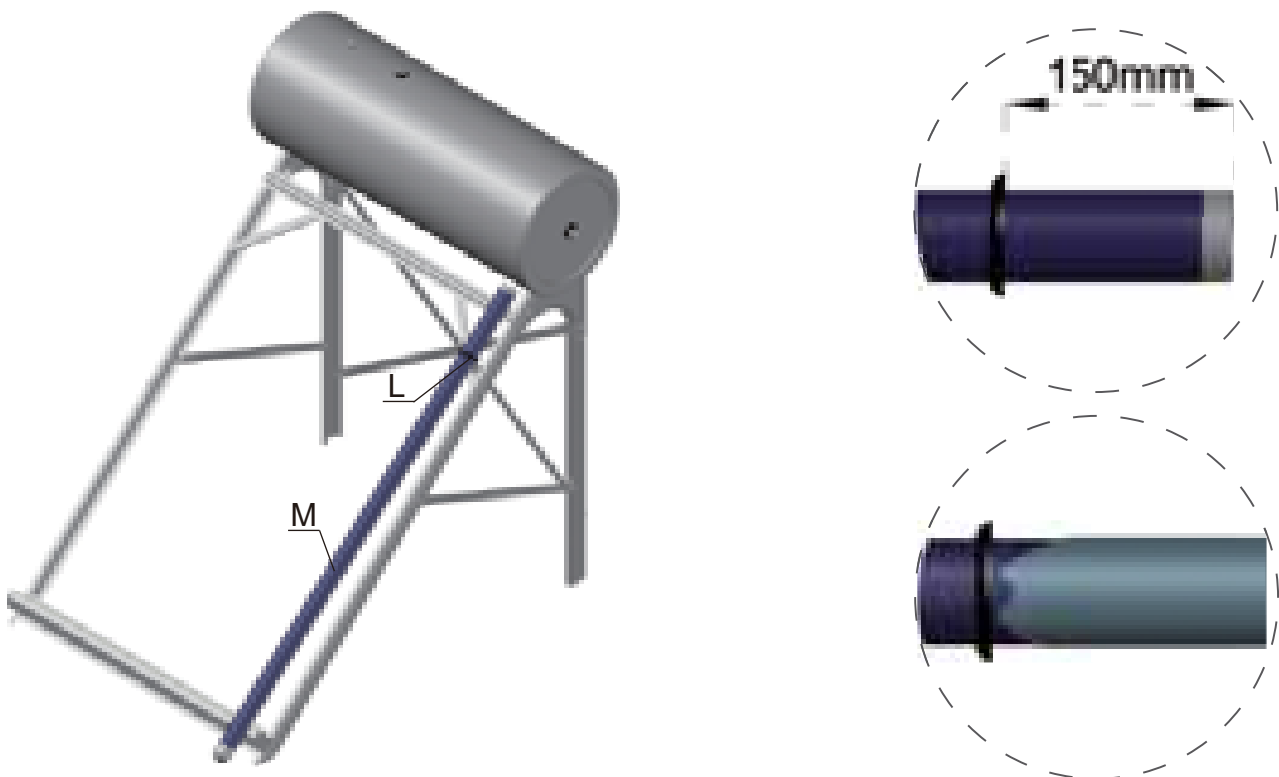

8. Put some lubricant such as detergent on the dust rings(L) and the open end of vacuum tubes(M) (for easy installation), put the dust rings onto vacuum tubes and slide it down about 150mm.

9. Rotate tube carefully (wear gloves)while pushing tube upwards into the tank. Be careful not to knock other end of tube on the frame or ground.

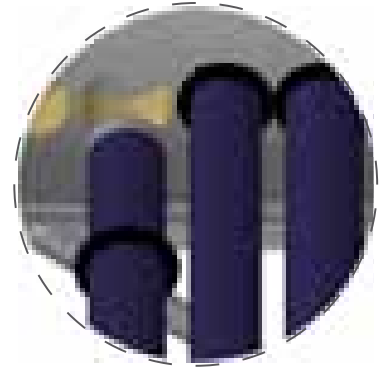

10. Now using a gentle downward pressure and twisting motion lower the tube until it fits snugly into the socket (K) on the tail stock, and make sure it fixed with dust ring(L) well.
11. Repeat next tubes in same way.



12. Place the pad (O) on main water tank, inlet water pipe is linked to the bottom of assistant tank (N) and screwed tightly.

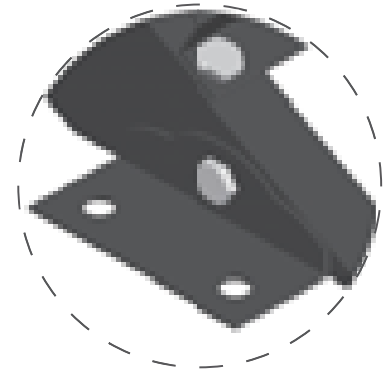
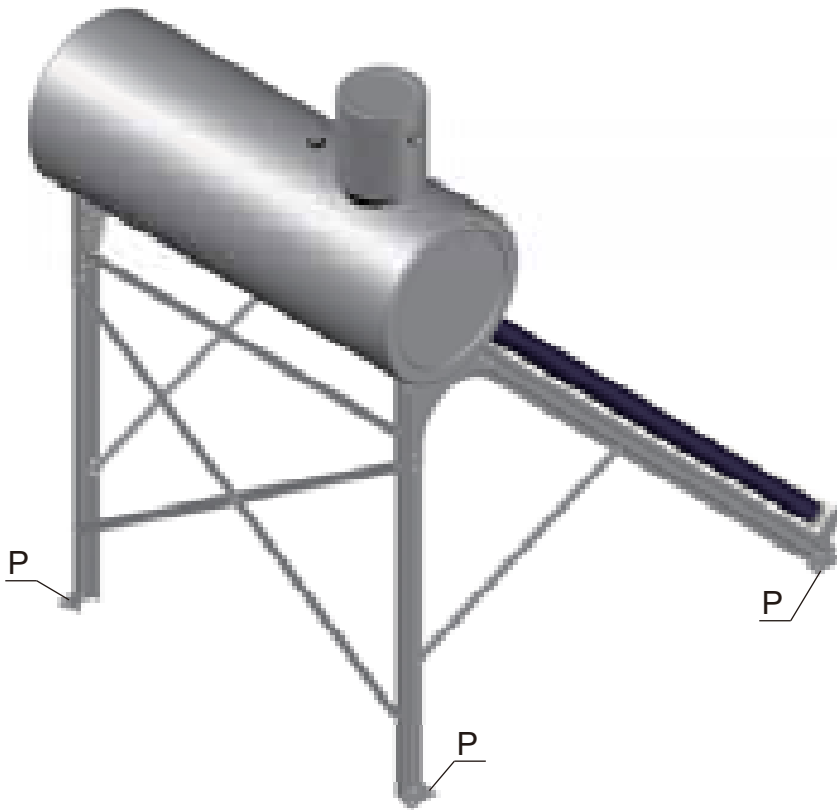

13. Install the leg pads(P), connect leg pads with ground by the inflated bolt. Fix it more than 4 steel ropes to avoid the demolishment from the strong wind.





Schematic diagram

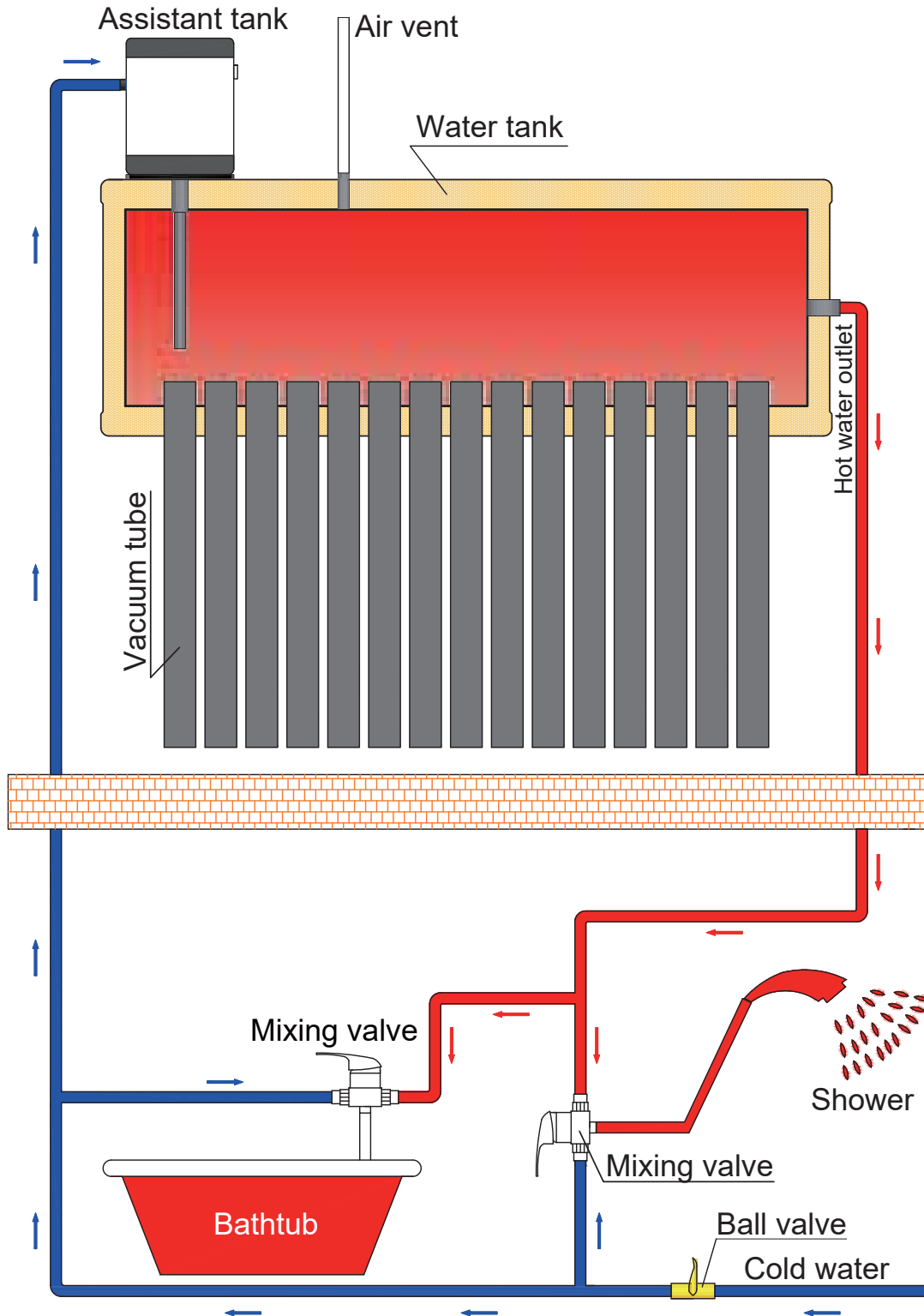

**The principle of solar water heater**

The vacuum tubes absorb the sun's rays and turn the rays into heat energy, heating the water in the tubes. As the temperature of the water is rising, the density turns slightly, then the hot water in the tubes floats into the tank, and the cold water in the tank goes down to the tubes. Keeping natural cycling like this, the water in the tank will be heated.

### The working principle of the assistant tank

1. After solar water heater installed, the tap water fill the tank and the vacuum tubes by the assistant tank. When the tank is full of water, the ball cock in the small tank will turn off the inlet to stop the water feeding.
2. The water in the tank and vacuum tubes expands when is heated, and this moment, the assistant tank can store the expanded hot water.
3. The water in the tank and vacuum tubes may reduce because of evaporation, the water will be filled by the small tank automatically. When the tank is filled up with water, it will stop.

The small tank has the function to keep the tank filled up with water always.

### Major technical parameter

Specification of the vacuum collector tube	58 × 1800 (mm)
Water capacity (liter)	100L, 150L
Material of the inner Water Tank	SUS304-2B food grade stainless steel
Material of the outer water tank	Stainless steel
Insulating layer and thickness	Foaming polyurethane thickness 50 mm
Material of the bracket	Stainless steel
Sealing rings	Silicon Rubber
Tilting angle to the ground	20 °
Average daily efficiency	≥47%
Temperature of the hot water ( °C )	45-95

### Location Selection

There are five major factors to consider when selecting the solar water heater installation location.

1. For optimum performance the solar collectors need to face the equator (in Southern hemisphere this is north and in the Northern hemisphere this is South). Installation on angles of up to 45° away from the equator do not have a major effect on the annual solar output, consequently roof locations which face less than 45° away from the equator are acceptable. If the collectors are installed with an east facing bias the best solar input is achieved in the morning and if there is a west facing bias the best solar input is in the afternoon.
2. Careful site inspection is required to ensure the selected location is not subjected to shading from adjacent trees or buildings throughout the day but particularly between 9am and 3pm the highest solar input times. Shadows are longer in winter than in summer so a site that is free of shadows from adjacent objects in summer may have some shadows in winter.
3. The solar water heater is to be located a minimum of 3 foot up from the roofs lower edge, 3 foot in from either side of the roof, and 3 foot down from the roofs ridge line and should be located as close as possible to the location which uses the most hot water, such as bathroom or kitchen. This is to reduce energy losses which may occur if the pipe work between the solar water heater and the point of usage is too long.
4. To achieve optimum performance the solar water heater should be installed on a roof pitch of greater than 8° and less than 30°. Installations on a roof where the roof pitch is greater than 30° will require additional support at the storage tank to prevent it moving downward after installation. If the roof pitch is less than 8°, the system will require a mounting frame to increase the pitch above 8°. Installations below 8° do not thermosiphon effectively and the collector glass will not self clean during rainy periods.
5. Careful inspection of the roof truss system is essential to ensure it can support the systems weight once filled with water. Particular care must be taken where the front foot of the storage tank is located. Typically the tank front foot should be located over a tile batten, purlin or similar for maximum strength. If the roof can not support the load additional bracing must be installed before the solar water heater is installed.

## When using the water

Open mixing valve to realize water supply. Adjust mixing valve until satisfactory water temperature and volume is obtained.



When showering, feel the water temperature with your hand to avoid scalding.

## Guideline for Users

1. Connect the cushion with building plate by the inflated bolt. Fix it more than 4 steel ropes to avoid the demolishment from the strong wind.
2. The temperature of the evacuated collector tube must be cooled down, when filling water for the first time.
3. To prevent scalding caused by overheated water, it is advised to feel the water temperature with a hand before showering. When adjusting the temperature, the hot water valve shall be adjusted to a suitable showering temperature according to the season, sun radiation and water pressure.
4. In cold winter, when the room temperature is low, heating light and/or heating fans can be used to increase the room temperature. In extremely cold districts, when didn't want to use the solar water heater, the water in the pipeline shall be completely drained out during winter to prevent the freezing crack damage to the pipeline.
5. In summer, water filling must be done immediately after the hot water was used up or at night. Otherwise, water in the tubes can be vapor after long exposure of sunshine and the temperature of the tubes will be up to 250 °C, fill water at this time will lead to crack the tubes.
6. Please don't shower when there is a thunderstorm and fill up the tank when there is a hurricane.
7. In summer, if the hot water use is little or the temperature is too high, you can use mask to cover some surface of the solar collector to reduced the heat absorption.

