

INSTALLATION MANUAL

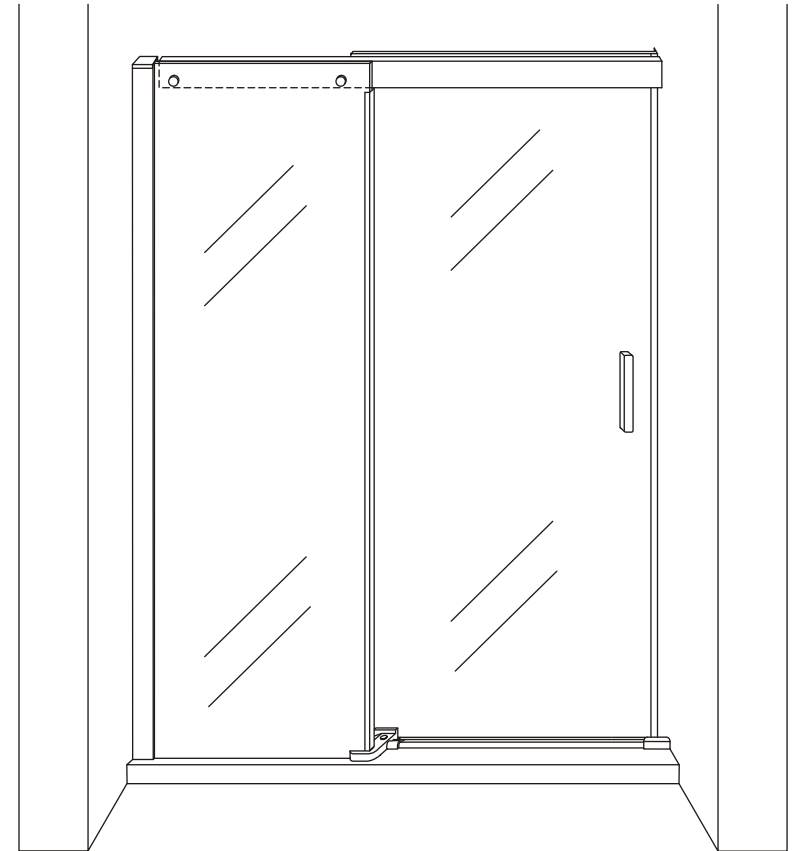

BL-P702

RoHS  **ISO9001:2000**

TOOL PICTURE

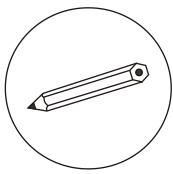

Pencil

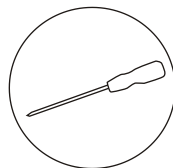

Cross screw driver

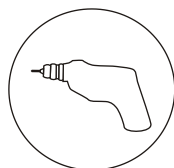

Drill machine (6mm)

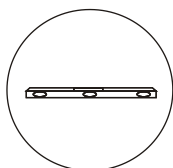

Level ruler

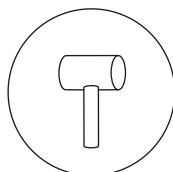

Rubber hammer

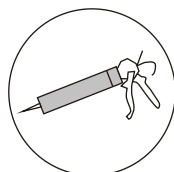

Silicon gel

Accessory list

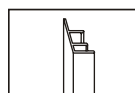

Side cover

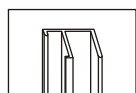

Wall profile

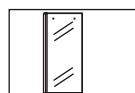

Glass

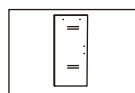

Glass

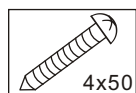

Screw 4x50

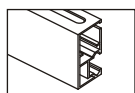

HGL-808

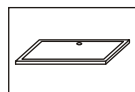

Tray

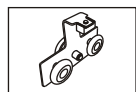

wheel

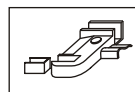

PJ-4706/
PJ-4707

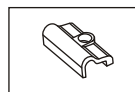

PJ-4578

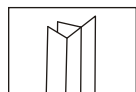

CT-8DST90

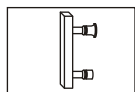

LS-1018

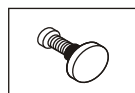

Glass screw

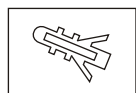

Expand tube

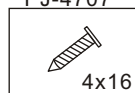

Screw 4x16

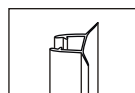

gasket



PJ-4012

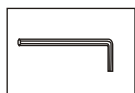

PJ-4026

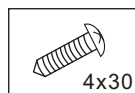

Screw 4x30

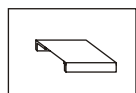

PJ-4608

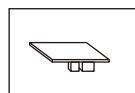

PJ-4607

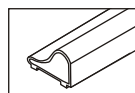

Aluminum
bottom bar

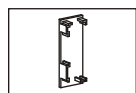

PJ-4702/
PJ-4703

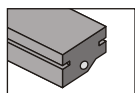

LTL-954

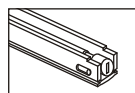

PJ-4699

1. Tighten the screws (five screws at the wall profile) , Put the cover on. Install the aluminium decoration.
2. Use silicon to seal the gap between aluminum track and shower tray.

Attention: Do not use any corrosion liquid to clean the aluminum and other metal parts when daily maintenance.

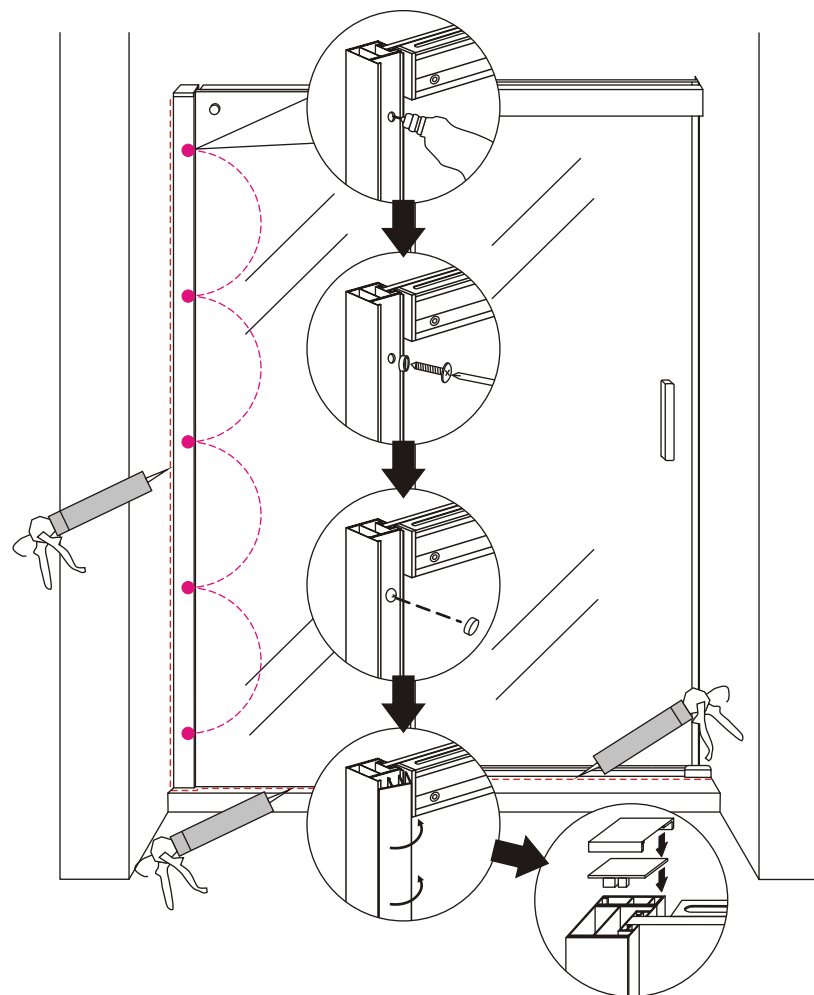
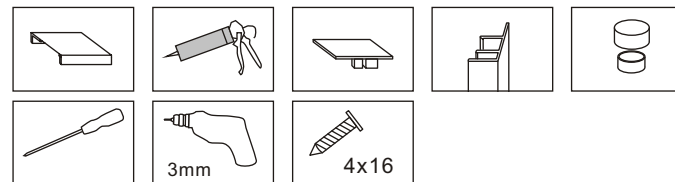

1. Install the water-proof gasket.
2. Install the handle.
3. Install the guide decorate part.

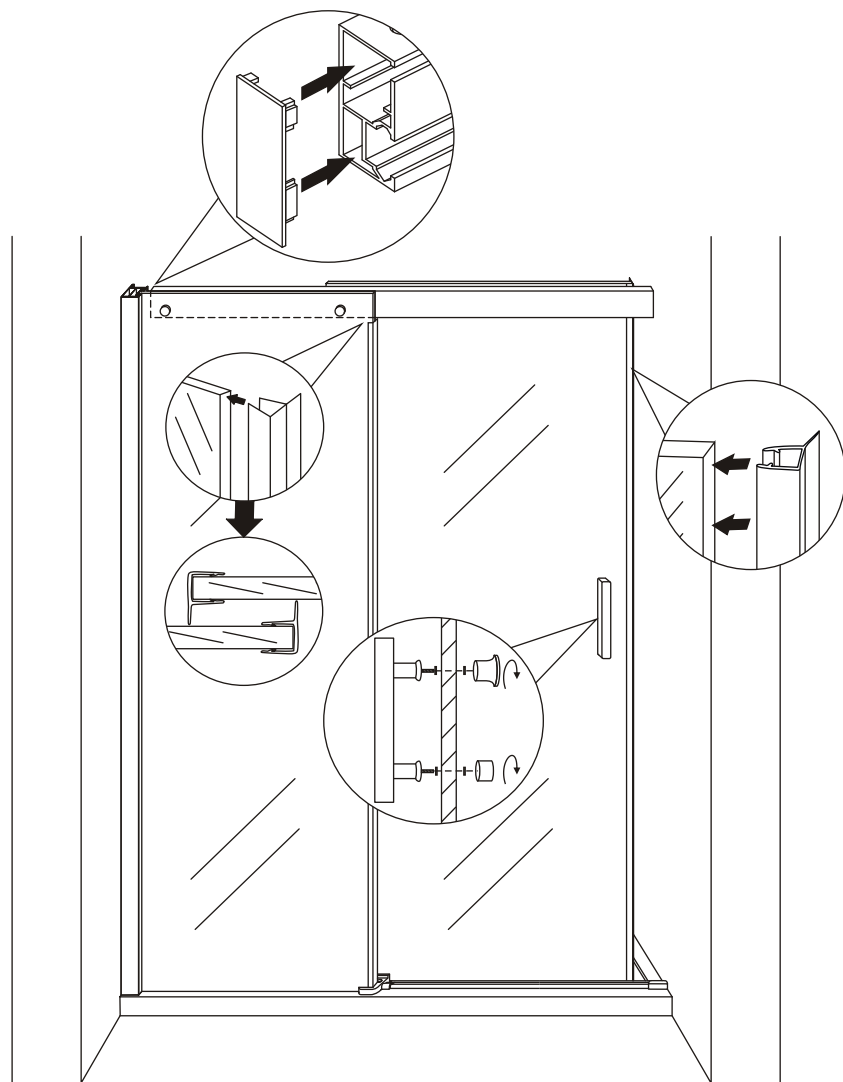

Put the tray on the floor and make sure it is level with a level ruler .

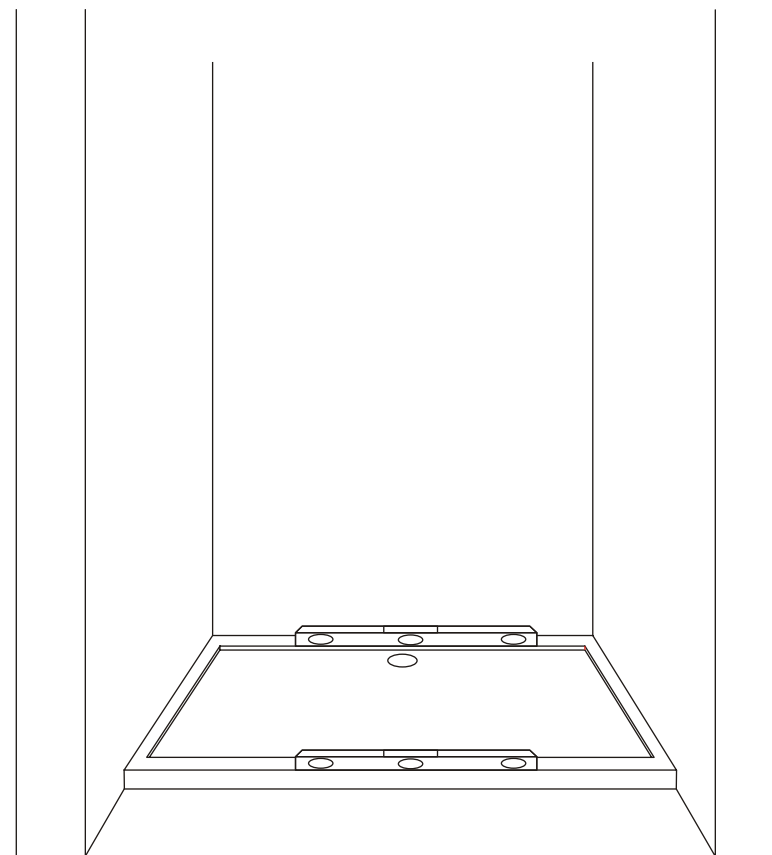
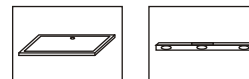

Install the wall aluminium profile.

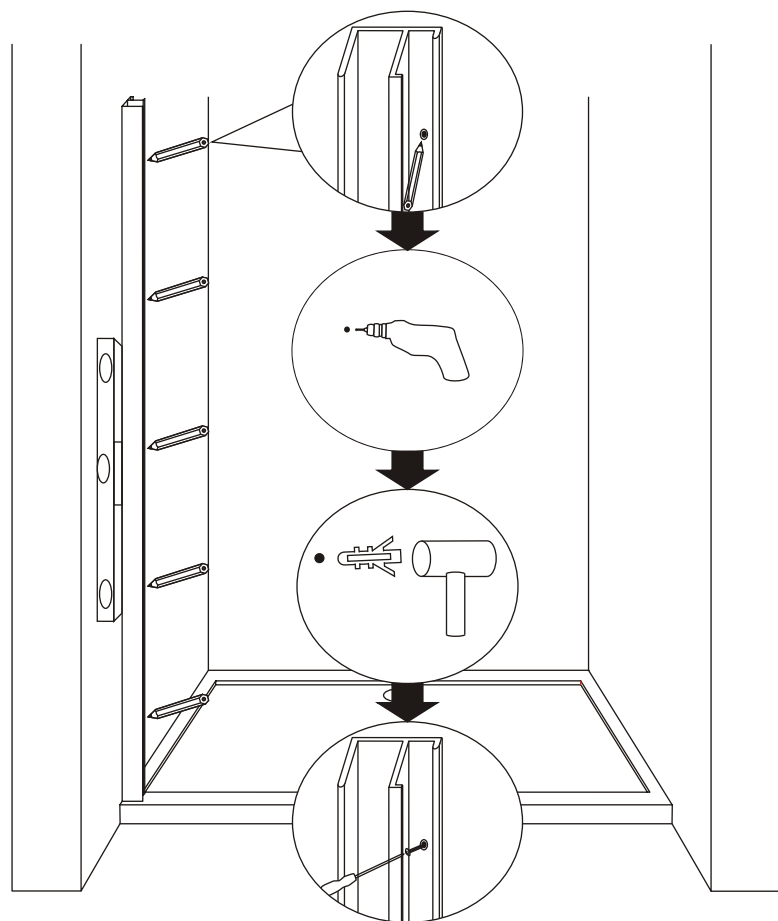
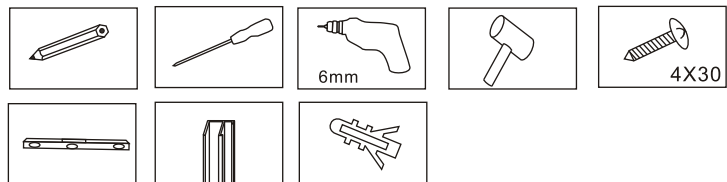

3

Install the door glass to the guide rail wheels by hexagon

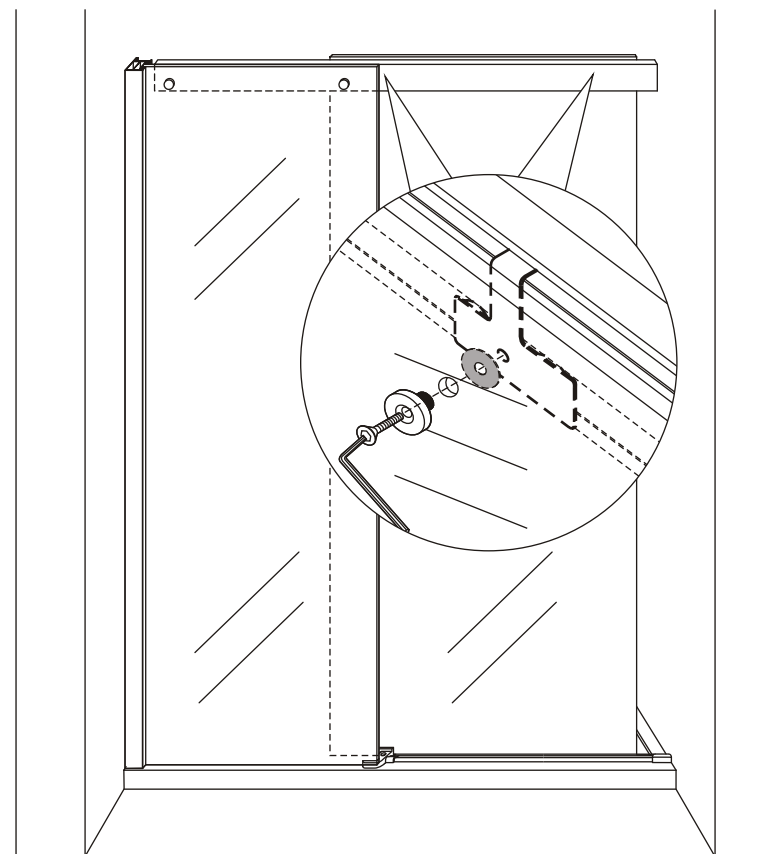

8

Install aluminum water-proof bar on the tray and fixed the plastic part.

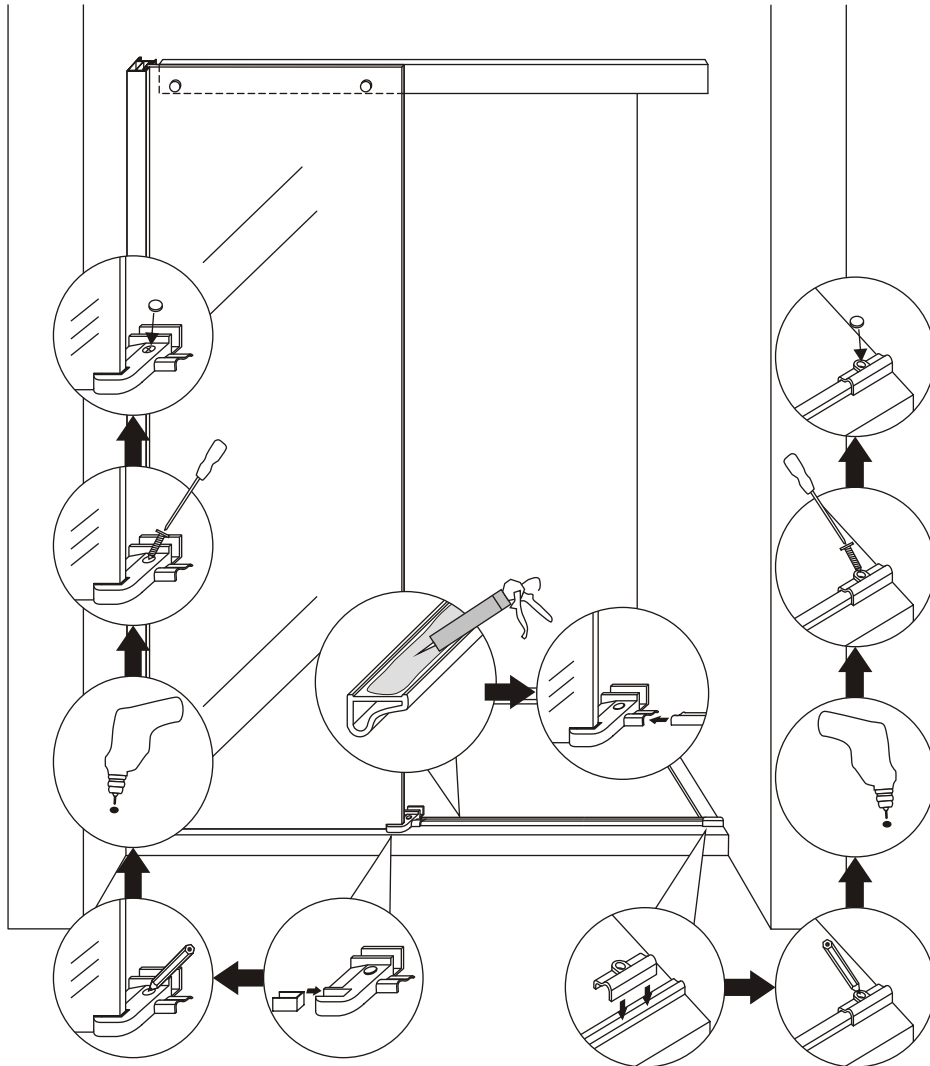
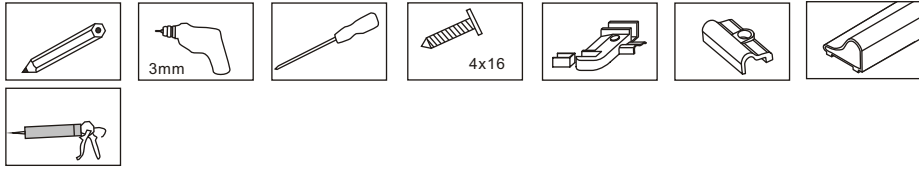

Insert the fixed glasses into the wall aluminum profile.

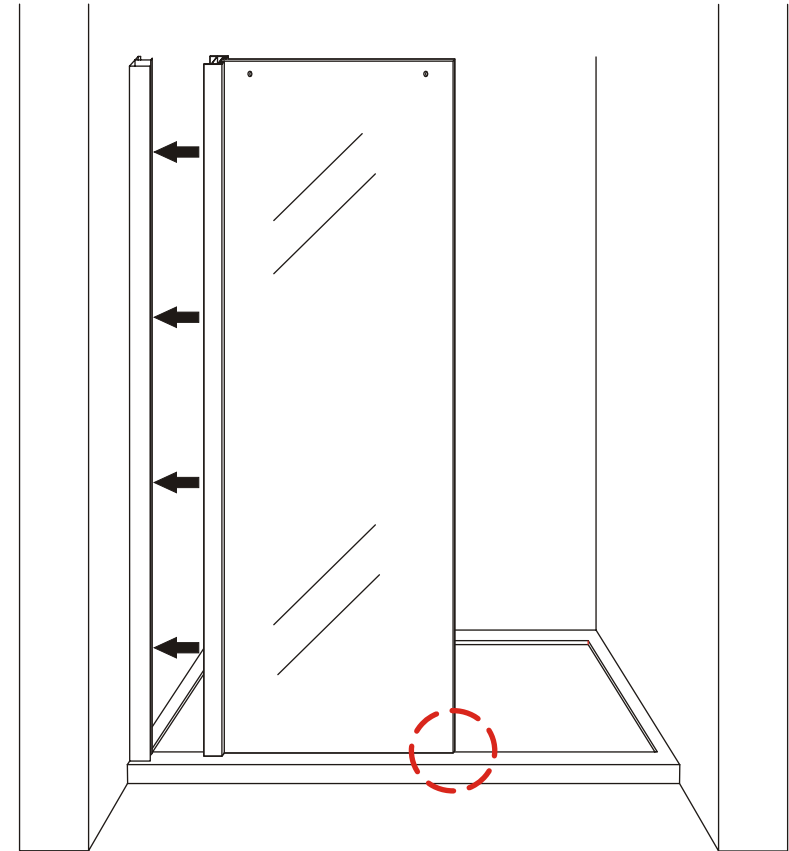
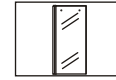

Attention: Do not remove the Black corner protector until insert well the glass into the wall profiles and fit well to prevent glass broken and splitted.



Install the connection guide support (Notice: First make sure the hole position on the wall and marked, the hole position to the tray is 1917mm, to the fixed door is 21mm).

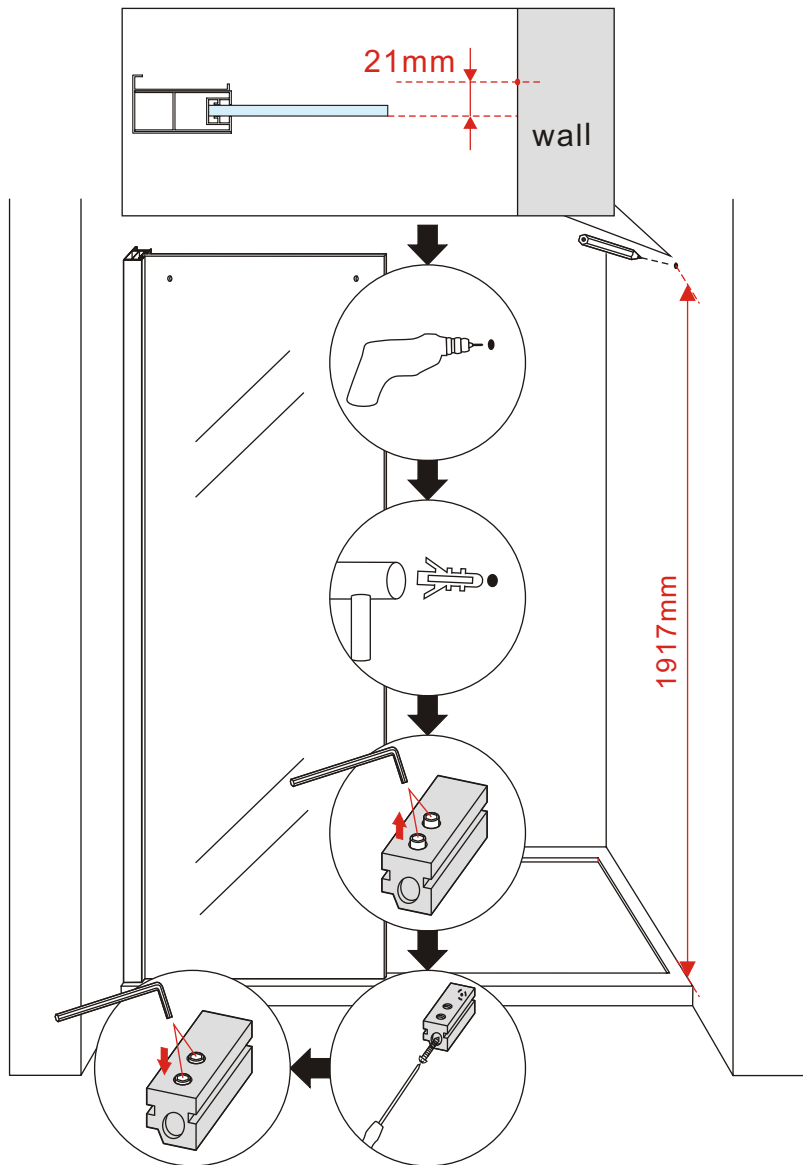
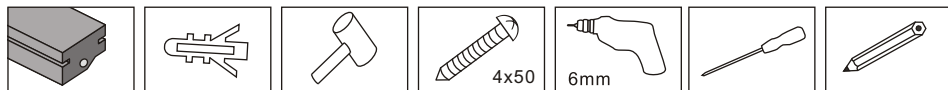

5

Install the Guide Rai: First of all put the first buffer into the guide rail and fixed it by screwdriver, next put two wheels into the guide rails then put the second buffer into guide rail and fixed by screwdriver then insert the guide rail into guide rail connect support, thirdly fixed the guide rail and glass by glass screw. finally fixed the guide rail and guide rail connect support by hexagon.

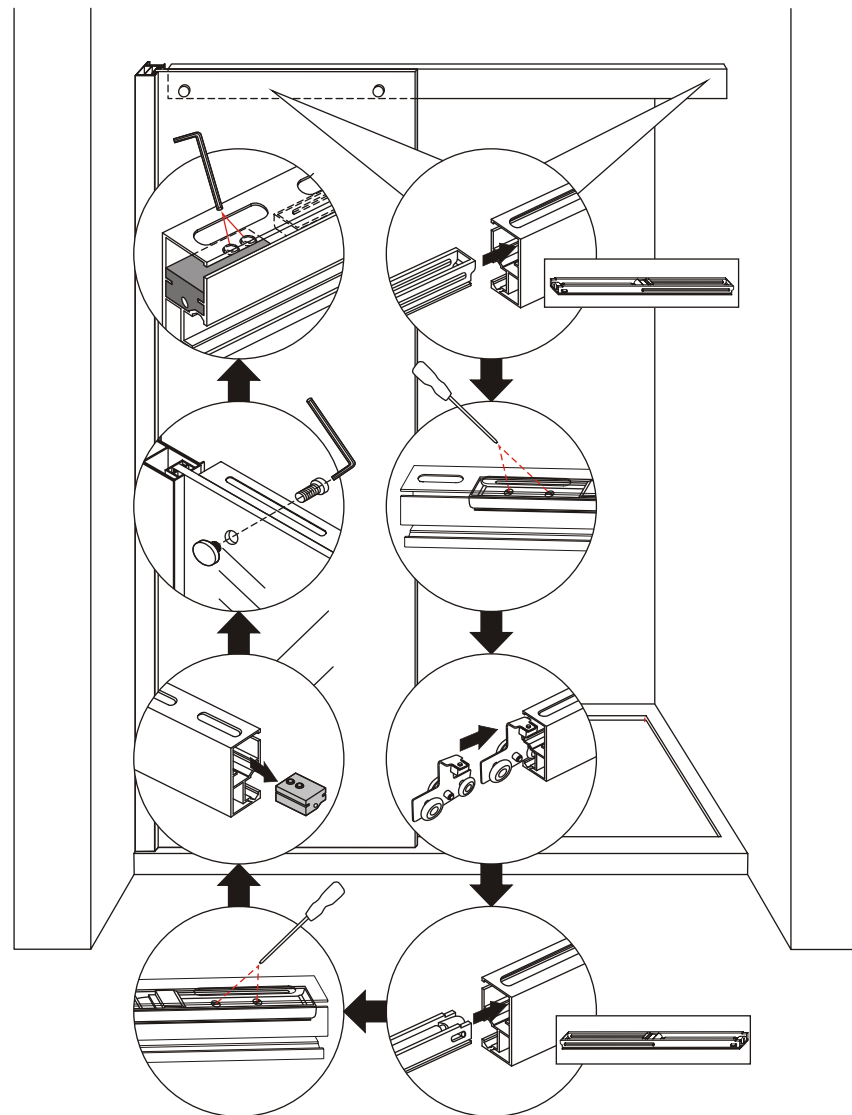
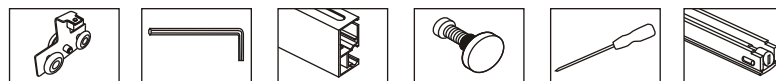

6