

MVE - Standard Range

► 2 POLES

3000-3600 rpm

Ex IBD T100°C resp T135°C - IP66
 TÜV NORD Statement Conformity Number TÜV 05 ATEX 2768X
 - Equipment and protective system intended for use in potentially explosive atmospheres (Zone 2) - Directive 94/9/EC
 - Compliance with Essential Health and Safety Requirements EN 61241-10



CE Declaration of conformity "type A" according to:
 - 73/23/EEC - 98/37/EEC - EN 60034-1
 Class II Div 2 Group FG - T6 - NEMA 4 conform to UL 1836 and CSA C22.2 N025
 Intertek ETL - SEMCO

TYPE	Mechanical Features						Electric Features								Cable Glande
	Working moment (*)		FC		Weight		Power		Current		Ia/In		Temp. Class Dust (°C)		
	Kgcm		Kg		Kg		Kw		A max (Y)		50Hz 60Hz				
	50Hz	60Hz	50Hz	60Hz	50Hz	60Hz	50 Hz	60 Hz	50 Hz	60 Hz	50Hz	60Hz			
MVE 60/3	1.35	0.82	68	59	4.2		0.08	0.09	0.16	0.18	3.0	3.0	100	M16	
MVE 100/3	2.01	1.52	101	110	4.6		0.1	0.11	0.19	0.18	3.0	3.0	100	M16	
MVE 200/3	3.72	2.61	187	189	7.0		0.18	0.21	0.35	0.35	3.3	3.30	100	M20	
MVE 202/3	3.72	2.61	187	189	7.2		0.18	0.21	0.35	0.35	3.3	3.30	100	M20	
MVE 300/3	6.39	4.46	321	323	9.8		0.27	0.28	0.52	0.45	3.60	3.50	100	M20	
MVE 400/3	7.96	5.68	407	411	10.3		0.30	0.36	0.58	0.60	3.50	3.50	100	M20	
MVE 500/3	10.27	7.38	530	534	15.8		0.50	0.58	0.96	0.97	4.00	4.20	100	M20	
MVE 700/3	14.90	10.57	758	765	16.5		0.66	0.75	1.25	1.24	4.30	5.00	100	M20	
MVE 800/3	15.68	11.06	794	800	20.6		0.75	0.90	1.45	1.50	3.80	3.80	100	M20	
MVE 1200/3	20.26	14.00	1005	1013	21.6		0.95	1.15	1.85	1.95	4.40	4.50	100	M20	
MVE 1300/3	27.58	18.86	1355	1365	22.0		1.30	1.38	2.44	2.25	5.20	5.00	100	M20	
MVE 1301/3	27.58	18.86	1355	1365	30.3		1.30	1.38	2.44	2.25	5.20	5.00	100	M20	
MVE 1310/3	22.34	22.34	1123	1616	30.0		1.30	1.38	2.44	2.25	5.20	5.00	100	M20	
MVE 1600/3	31.26	22.22	1601	1608	51.6	51.2	1.57	1.60	2.94	2.61	5.90	6.20	135	M25	
MVE 2000/3	36.78	27.60	2027	1997	52.8	52.0	2.00	2.10	3.75	3.42	6.50	6.40	135	M25	
MVE 2300/3	45.97	31.87	2302	2306	53.6	51.6	2.40	2.45	4.44	3.94	6.00	6.30	135	M25	
MVE 3200/3	68.10	43.89	3252	3176	103.0	101.4	2.90	2.90	5.30	4.61	8.30	8.20	135	M32	
MVE 4000/3	79.40	55.99	4033	4052	107.0	103.8	2.90	2.90	5.30	4.61	8.5	9.7	135	M32	
MVE 5000/3	103.24	69.76	5009	5048	111.2	105.8	4.00	4.00	7.22	6.28	8.50	9.80	135	M32	

(*) = Working moment = 2 x static moment

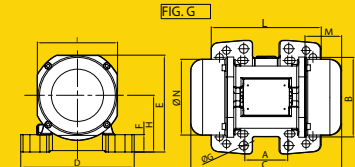
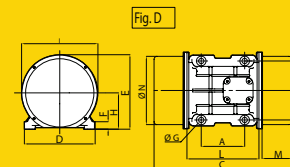
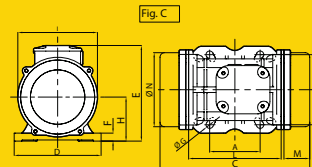
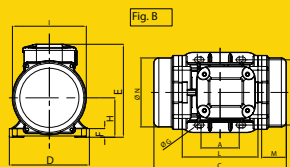
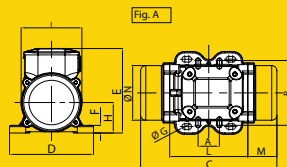
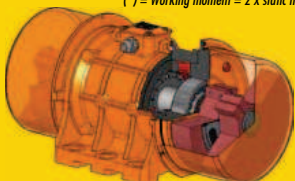

TYPE	FIG.	Size	Dimensional Features															
			C (mm)		M (mm)		A (mm)	B (mm)	Ø G (mm)	Holes n°	D (mm)	E (mm)	F (mm)	H (mm)	I (mm)	L (mm)	N (mm)	
			50Hz	60Hz	50Hz	60Hz												
MVE 60/3	A	10	211	45	*	*	*	4	130	136	12	48	94	121	85			
MVE 100/3	A	10	211	45	*	*	*	4	130	136	12	48	94	121	85			
MVE 200/3	B	20	219	41	62-74	106	9	4	131	159	15	64	121	123	112			
MVE 202/3	G	23	218	53	**	**	**	4	164	140	25	82	116	159	110			
MVE 300/3	C	30	260	43	***	***	***	4	154	175	15	79	142	163	131			
MVE 400/3	C	30	260	43	***	***	***	4	154	175	15	79	142	163	131			
MVE 500/3	D	40	338	75	105	140	13	4	168	196	22	92	169	178	158			
MVE 700/3	D	40	338	75	105	140	13	4	168	196	22	92	169	178	158			
MVE 800/3	D	50	311	47	120	170	17	4	208	210	22	94	180	205	170			
MVE 1200/3	D	50	311	47	120	170	17	4	208	210	22	94	180	205	170			
MVE 1300/3	D	50	321	47	120	170	17	4	208	210	22	94	180	205	170			
MVE 1301/3	D	53	321	47	100	180	17	4	236	210	26	98	180	205	170			
MVE 1310/3	D	55	321	47	100	200	17	4	236	210	26	98	180	205	170			
MVE 1600/3	D	60	418	83	140	190	17	4	229	247	30	120	247	220	222			
MVE 2000/3	D	60	418	83	140	190	17	4	229	247	30	120	247	220	222			
MVE 2300/3	D	60	418	83	140	190	17	4	229	247	30	120	247	220	222			
MVE 3200/3	D	75	538	115	155	255	25	4	302	318	35	147	295	273	264			
MVE 4000/3	D	75	538	115	155	255	25	4	302	318	35	147	295	273	264			
MVE 5000/3	D	75	588	538	140	115	155	255	25	4	302	318	35	147	295	273	264	

Fig. A

A	B	Ø G
mm	mm	mm
62-74	106	9
33	83-102	7

Fig. C

A	B	Ø G
mm	mm	mm
62-74	106	9
65	140	13
115	135	11
135	115	11

Fig. C

A	B	Ø G
mm	mm	mm
80	110	11
90	125	13
124	110	11
135	115	11

NOTE: Dimensions with coarse degree of accuracy related to UNI 22768/1

MVE - Standard Range

► 4 POLES

1500-1800 rpm

Ex IIBD T100°C resp T135°C - IP66
 TÜV NORD Statement Conformity Number TÜV 05 ATEX 2768X
 - Equipment and protective system intended for use in potentially explosive atmospheres (Zone 22) - Directive 94/9/EC
 - Compliance with Essential Health and Safety Requirements EN 61241-10



CE Declaration of conformity "type A" according to:
 - 73/23/EEC - 98/37/EEC - EN 60034-1

Class II Div.2 Group FG - T6 - NEMA 4 conform to UL 1836 and CSA C22.2 NO25 Intertek ETL - SEMCO

TYPE	Mechanical Features						Electric Features							Cable Glande
	Working moment (*)		FC		Weight		Power		Current		Ia/In		Temp. Class Dust (°C)	
	Kgcm		Kg		Kg		Kw		A max (Y)					
	50Hz	60Hz	50Hz	60Hz	50Hz	60Hz	50 Hz	60 Hz	50 Hz	60 Hz	50Hz	60Hz		
MVE 40/15	2.15	1.99	27	36	4.6	0.04	0.05	0.31	0.31	1.00	1.00	100	M16	
MVE 90/15	5.97	4.2	75	76	7.4	0.09	0.1	0.26	0.25	1.00	1.00	100	M20	
MVE 200/15	15.44	10.83	194	196	11.8	0.16	0.17	0.49	0.50	1.00	1.00	100	M20	
MVE 400/15	33.43	23.38	420	423	19.5	0.30	0.35	0.84	0.86	2.50	2.50	100	M20	
MVE 500/15	40.12	28.08	504	508	21.0	0.35	0.40	1.06	1.09	2.80	2.70	100	M20	
MVE 300/15	26.58	18.60	334	336	22.5	0.62	0.73	1.32	1.41	3.00	3.20	100	M20	
MVE 700/15	56.83	39.36	714	712	27.4	0.62	0.73	1.32	1.41	3.00	3.20	100	M20	
MVE 1100/15	88.67	62.02	1114	1122	35.8	0.65	0.78	1.50	1.70	3.80	3.80	100	M20	
MVE 1400/15	108.57	76.72	1364	1388	59.8	0.90	1.10	1.71	1.78	4.00	4.00	135	M25	
MVE 1700/15	137.31	91.98	1725	1664	61.8	1.15	1.30	2.16	2.09	4.70	4.50	135	M25	
MVE 2400/15	187.69	137.36	2358	2485	68.0	1.60	1.90	3.00	3.20	4.90	4.90	135	M25	
MVE 2500/15	203.53	135.65	2557	2454	90.0	1.80	2.00	3.40	3.40	6.00	6.10	135	M25	
MVE 3000/15	248.66	169.75	3124	3071	97.5	1.90	2.30	3.70	3.80	6.50	6.60	135	M25	
MVE 3800/15	306.69	204.74	3853	3704	130.4	2.20	2.60	4.12	4.15	6.80	6.80	135	M32	
MVE 4300/15	343.22	240.95	4312	4359	134.4	2.50	3.00	5.70	5.80	7.00	7.20	135	M32	
MVE 5500/15	437.39	303.74	5495	5495	192.2	3.60	3.45	6.50	6.60	7.10	7.00	135	M32	

TYPE	Mechanical Features						Electric Features							Cable Glande
	Working moment (*)		FC		Weight		Power		Current		Ia/In		Temp. Class Dust (°C)	
	Kgcm		Kg		Kg		Kw		A max (Δ)					
	50Hz	60Hz	50Hz	60Hz	50Hz	60Hz	50 Hz	60 Hz	50 Hz	60 Hz	50Hz	60Hz		
MVE 7200/15	576.76	397.32	7246	7188	253.0	5.00	6.00	9.60	9.41	6.80	6.90	135	M32	
MVE 9000/15	717.97	498.76	9020	9023	268.6	7.50	8.50	12.00	12.00	7.00	7.00	135	M32	
MVE 10000/15	800.11	588.30	10052	10643	311.8	7.80	9.40	13.00	13.00	6.50	6.40	135	M32	

(*) = Working moment = 2 x static moment

TYPE	FIG	Size	Dimensional Features															
			C		M		A	B	Ø G	Holes	D	E	F	H	I	L	N	
			50Hz	60Hz	50Hz	60Hz	(mm)	(mm)	(mm)	n°	(mm)	(mm)	(mm)	(mm)	(mm)	(mm)	(mm)	
MVE 40/15	A	10	211	45	*	*	*	4	130	136	12	48	94	121	85			
MVE 90/15	B	20	219	41	62-74	106	9	4	131	159	15	64	121	123	112			
MVE 200/15	C	30	260	43	***	***	***	4	154	175	15	79	142	163	131			
MVE 400/15	D	40	338	75	105	140	13	4	168	196	22	92	169	178	158			
MVE 500/15	D	40	338	75	105	140	13	4	168	196	22	92	169	178	158			
MVE 300/15	D	50	311	47	120	170	17	4	208	210	22	94	180	205	170			
MVE 700/15	D	50	397	90	120	170	17	4	208	210	22	94	180	205	170			
MVE 1100/15	D	50	451	112	120	170	17	4	208	210	22	94	180	205	170			
MVE 1400/15	D	60	448	98	140	190	17	4	229	247	30	120	247	220	222			
MVE 1700/15	D	60	448	98	140	190	17	4	229	247	30	120	247	220	222			
MVE 2400/15	D	60	510	448	129	98	140	190	17	4	229	247	30	120	247	220	222	
MVE 2500/15	D	70	522	486	123	105	155	225	22	4	272	284	40	140	267	250	235	
MVE 3000/15	D	70	522	486	123	105	155	225	22	4	272	284	40	140	267	250	235	
MVE 3800/15	D	75	588	538	140	115	155	255	23.5	4	302	318	35	147	295	273	264	
MVE 4300/15	D	75	588	538	140	115	155	255	23.5	4	302	318	35	147	295	273	264	
MVE 5500/15	D	80	603	130	180	280	26	4	332	360	37	167	345	304	310			

TYPE	FIG	Size	Dimensional Features															
			C		M		A	B	Ø G	Holes	D	E	F	H	I	L	N	
			50Hz	60Hz	50Hz	60Hz	(mm)	(mm)	(mm)	n°	(mm)	(mm)	(mm)	(mm)	(mm)	(mm)	(mm)	
MVE 7200/15	D	85	605	120	200	320	28	4	385	410	49	200	422	325	378			
MVE 9000/15	D	85	605	120	200	320	28	4	385	410	49	200	422	325	378			
MVE 10000/15	E	90	726	646	160	120	125	380	38	6	452	430	44	204	422	367	378	

Fig. A

A	B	Ø G
mm	mm	mm
62-74	106	9
33	83-102	7

Fig. C

A	B	Ø G
mm	mm	mm
80	110	11
90	125	13
124	110	11
135	115	11

NOTE: Dimensions with coarse degree of accuracy related to UNI 22768/1

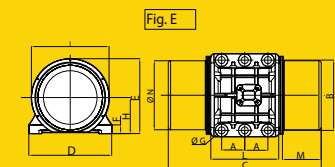
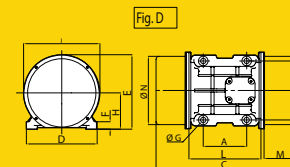
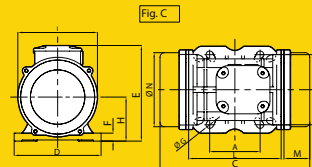
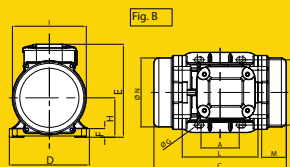
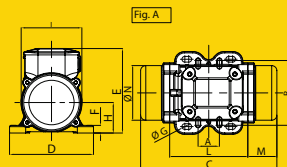

MVE - Standard Range

► 6 POLES

1000-1200 rpm

Ex IIBD T100°C resp T135°C - IP66
 TÜV NORD Statement Conformity Number TÜV 05 ATEX 2768X
 - Equipment and protective system intended for use in potentially explosive atmospheres (Zone 2) - Directive 94/9/EC
 - Compliance with Essential Health and Safety Requirements
 EN 61241-10



CE Declaration of conformity "Type A" according to:
 - 73/23/EEC - 98/37/EEC - EN 60034-1
 IEC Class II Div.2 Group EG - T6 - NEMA 4 conform to UL 1836 and CSA C22.2 N025
 Intertek ETL - SEMCO

TYPE	Mechanical Features						Electric Features										Cable Glande
	Working moment (*)		FC		Weight		Power				Current		Ia/In		II 3D Temp. Class Dust (°C)		
	Kgcm		Kg		Kg		Kw		Hp		A max (Y)		50Hz/60Hz				
	50Hz	60Hz	50Hz	60Hz	50Hz	60Hz	50 Hz	60 Hz	50 Hz	60 Hz	50 Hz	60 Hz	50Hz	60Hz			
MVE 50/1	9.49	6.59	53	53	10.4		0.12	0.14	0.16	0.19	0.40	0.40	1.00	1.00	100	M20	
MVE 100/1	18.80	13.18	105	106	12.2		0.12	0.14	0.16	0.19	0.40	0.40	1.00	1.00	100	M20	
MVE 200/1	33.49	23.38	187	188	19.6		0.18	0.21	0.24	0.28	0.53	0.51	1.00	1.00	100	M20	
MVE 300/1	47.82	33.46	267	269	26.6		0.35	0.38	0.47	0.51	0.67	0.64	2.50	2.50	100	M20	
MVE 500/1	91.88	64.32	513	517	34.0		0.35	0.40	0.47	0.54	1.20	1.15	2.80	2.70	100	M20	
MVE 510/1	91.88	91.88	513	739	34.5		0.35	0.40	0.47	0.54	1.20	1.15	2.80	2.70	100	M20	
MVE 800/1	137.37	108.58	767	873	61.8	59.4	0.68	0.76	0.91	1.02	1.29	1.26	2.80	2.80	135	M25	
MVE 1100/1	187.69	137.31	1048	1104	79.4	73.0	0.75	0.80	1.01	1.07	1.42	1.32	3.20	3.10	135	M25	
MVE 1500/1	284.76	196.51	1590	1580	83.6	76.5	1.10	1.30	1.48	1.74	2.10	2.00	3.30	3.30	135	M25	
MVE 1600/1	299.63	203.47	1673	1636	99.8	89.0	1.10	1.30	1.48	1.74	2.83	3.22	3.70	3.60	135	M25	
MVE 2100/1	373.05	248.74	2063	2000	114.3	100.5	1.50	1.80	2.01	2.41	3.00	3.00	4.30	4.40	135	M25	
MVE 2600/1	467.44	306.70	2610	2466	148.6	131.5	1.96	2.10	2.63	2.82	3.63	3.38	4.80	4.80	135	M32	
MVE 3000/1	540.33	379.71	3017	3053	155.4	137.8	2.20	2.40	2.95	3.22	4.50	4.30	5.00	5.00	135	M32	
MVE 3800/1	680.38	437.41	3799	3517	215.6	194.8	2.50	3.00	3.35	4.02	4.67	4.88	5.90	6.00	135	M32	
MVE 4700/1	838.34	584.17	4681	4697	230.8	212.4	3.20	3.90	4.29	5.23	6.50	6.00	5.50	5.70	135	M32	
MVE 5200/1	929.86	654.57	5192	5263	279.8	264.2	3.80	4.00	5.10	5.36	6.92	6.36	5.50	5.50	135	M32	
MVE 6500/1	1165.19	823.96	6506	6625	304.4	280.7	4.30	5.00	5.77	6.71	7.76	7.81	6.20	6.00	135	M32	

TYPE	Mechanical Features						Electric Features										Cable Glande
	Working moment (*)		FC		Weight		Power				Current		Ia/In		II 3D Temp. Class Dust (°C)		
	Kgcm		Kg		Kg		Kw		Hp		A max (Δ)		50Hz/60Hz				
	50Hz	60Hz	50Hz	60Hz	50Hz	60Hz	50 Hz	60 Hz	50 Hz	60 Hz	50 Hz	60 Hz	50Hz	60Hz			
MVE 8000/1	1435.98	929.80	8018	7476	325.2	290	7.10	7.50	9.52	10.06	12.60	11.60	6.00	6.20	135	M32	
MVE 9000/1	1600.39	1165.23	8936	9369	337.8	307.6	7.50	8.30	10.06	11.13	13.20	12.60	6.30	6.20	135	M32	
MVE 10000/1	1788.44	1239.98	9986	9970	385.8	359.3	7.60	8.00	10.19	10.73	13.50	12.70	6.40	6.40	135	M32	
MVE 13000/1	2329.84	1647.42	13009	13246	422.2	375.6	10.00	10.00	13.41	13.41	17.00	16.00	6.40	6.2	135	M32	

(*) = Working moment = 2 x static moment

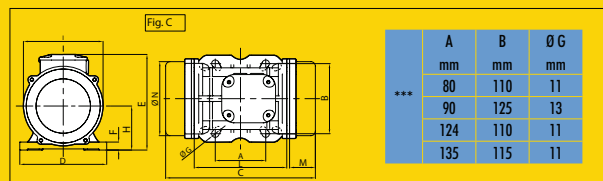
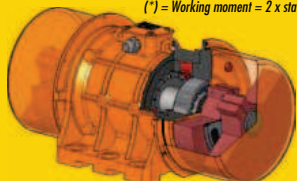

TYPE	FIG.	Size	Dimensional Features														
			C (mm)		M (mm)		A (mm)	B (mm)	Ø G (mm)	Holes (n°)	D (mm)	E (mm)	F (mm)	H (mm)	I (mm)	L (mm)	N (mm)
			50Hz	60Hz	50Hz	60Hz											
MVE 50/1	C	30	260	43	***	***	***	4	154	175	15	79	142	163	131		
MVE 100/1	C	30	300	63	***	***	***	4	154	175	15	79	142	163	131		
MVE 200/1	D	40	338	75	105	140	13	4	168	196	22	92	169	178	158		
MVE 300/1	D	50	397	90	120	170	17	4	208	210	22	94	180	205	170		
MVE 500/1	D	50	441	112	120	170	17	4	208	210	22	94	180	205	170		
MVE 510/1	D	50	451	112	120	170	17	4	208	210	22	94	180	205	170		
MVE 800/1	D	60	448	98	140	190	17	4	229	247	30	120	247	220	222		
MVE 1100/1	D	60	510	448	129	98	140	190	17	4	229	247	30	120	247	220	222
MVE 1500/1	D	60	562	510	154	129	140	190	17	4	229	247	30	120	247	220	222
MVE 1600/1	D	70	556	522	140	123	155	225	22	4	272	284	40	140	267	250	235
MVE 2100/1	D	70	616	522	170	123	155	225	22	4	272	284	40	140	267	250	235
MVE 2600/1	D	75	708	588	200	140	155	255	23.5	4	302	318	35	147	295	273	264
MVE 3000/1	D	75	708	608	200	150	155	255	23.5	4	302	318	35	147	295	273	264
MVE 3800/1	D	80	683	603	170	130	180	280	26	4	332	360	37	167	345	304	310
MVE 4700/1	D	80	733	683	195	170	180	280	26	4	332	360	37	167	345	304	310
MVE 5200/1	D	85	685	605	160	120	200	320	28	4	385	410	49	200	422	325	378
MVE 6500/1	D	85	685	160	200	320	28	4	385	410	49	200	422	325	378		

TYPE	FIG.	Size	Dimensional Features														
			C (mm)		M (mm)		A (mm)	B (mm)	Ø G (mm)	Holes (n°)	D (mm)	E (mm)	F (mm)	H (mm)	I (mm)	L (mm)	N (mm)
			50Hz	60Hz	50Hz	60Hz											
MVE 8000/1	D	85	785	685	210	160	200	320	28	4	385	410	49	200	422	325	378
MVE 9000/1	D	85	785	685	210	160	200	320	28	4	385	410	49	200	422	325	378
MVE 10000/1	E	90	826	210	125	380	38	6	452	430	44	204	422	367	378		
MVE 13000/1	E	90	926	826	260	210	125	380	38	6	452	430	44	204	422	367	378

NOTE: Dimensions with coarse degree of accuracy related to UNI 22768/1

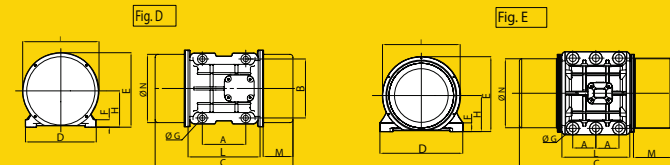

MVE - Standard Range
 ► 8 POLES
 750-900 rpm

Ex II 3D T100 °C resp T135 °C – IP66
 TÜV NORD Statement Conformity Number TUV 05 ATEX 2768X
 - Equipment and protective system intended for use in potentially explosive atmospheres (Zone 22) - Directive 94/9/EC
 - Compliance with Essential Health and Safety Requirements EN 61241-10



CE Declaration of conformity "Type A" according to:
 - 73/23/EEC - 90/37/EEC - EN 60034-1 - EN 60034-1 - EN 61000-6-2 - EN 61000-6-4
UL Class II Div.2 Group FG - T6 - NEMA 4 conform to UL 1836 and CSA C22.2 NO25 Intertek ETL - SEMCO

TYPE	Mechanical Features				Electric Features							
	Working moment (*) Kgcm 50Hz - 60Hz	FC Kg		Weight Kg 50Hz - 60Hz	Power Kw		Current A max (Y)		Ia/In		II 3D	Cable Glande
		50Hz	60Hz		50 Hz	60 Hz	50Hz	60Hz	Temp. Class Dust (°C)			
										400V	460V	
MVE 150/075	33.39	105	151	21.4	0.23	0.25	1.14	1.14	1.50	1.50	100	M20
MVE 250/075	57.27	180	259	29.5	0.35	0.38	1.15	1.15	1.70	1.70	100	M20
MVE 400/075	84.02	264	380	35.0	0.35	0.38	1.15	1.15	1.90	1.90	100	M20
MVE 650/075	137.31	431	621	64.7	0.50	0.60	1.20	1.20	2.20	2.20	135	M25
MVE 900/075	187.72	589	849	71.0	0.65	0.78	1.23	1.29	2.50	2.50	135	M25
MVE 1300/075	299.60	941	1355	99.8	1.00	1.10	1.86	1.83	3.00	3.00	135	M25
MVE 2100/075	467.41	1468	2114	150.4	1.50	1.80	2.81	2.89	4.20	4.10	135	M32
MVE 3100/075	680.34	2137	3077	212.2	2.00	2.30	3.79	3.77	4.00	4.00	135	M32
MVE 3800/075	838.43	2633	3792	230.2	2.50	3.00	6.00	6.00	3.90	4.00	135	M32
MVE 4200/075	929.74	2920	4205	284.5	2.90	3.40	6.50	6.50	3.80	3.70	135	M32
MVE 5300/075	1165.22	3660	5270	305	4.00	4.30	8.50	8.00	3.80	4.20	135	M32
MVE 6500/075	1435.85	4510	6494	324.4	5.00	5.90	10.00	10.00	3.60	4.00	135	M32

TYPE	Dimensional Features														
	FIG.	Size	C (mm) 50Hz - 60Hz	M (mm) 50Hz - 60Hz	A	B	Ø G	Holes	D	E	F	H	I	L	N
					(mm)	(mm)	(mm)	n°	(mm)	(mm)	(mm)	(mm)	(mm)	(mm)	(mm)
MVE 150/075	D	40	338	75	105	140	13	4	168	196	22	92	169	178	158
MVE 250/075	D	50	397	90	120	170	17	4	208	210	22	94	180	205	170
MVE 400/075	D	50	441	112	120	170	17	4	208	210	22	94	180	205	170
MVE 650/075	D	60	448	98	140	190	17	4	229	247	30	120	247	220	222
MVE 900/075	D	60	510	129	140	190	17	4	229	247	30	120	247	220	222
MVE 1300/075	D	70	556	140	155	225	22	4	272	284	40	140	267	250	235
MVE 2100/075	D	75	708	200	155	255	23.5	4	302	318	35	147	295	273	264
MVE 3100/075	D	80	683	170	180	280	26	4	332	360	37	167	345	304	310
MVE 3800/075	D	80	733	195	180	280	26	4	332	360	37	167	345	304	310
MVE 4200/075	D	85	685	160	200	320	28	4	385	410	49	199	422	325	378
MVE 5300/075	D	85	685	160	200	320	28	4	385	410	49	199	422	325	378
MVE 6500/075	D	85	785	210	200	320	28	4	385	410	49	199	422	325	378

(*) = Working moment = 2 x static moment

NOTE: Dimensions with coarse degree of accuracy related to UNI 22768/1

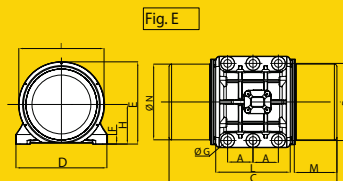
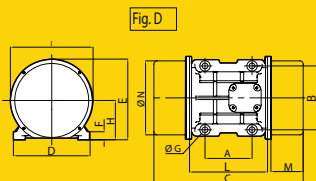
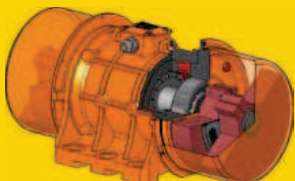

MVE - Standard Range
 ▶ 2 POLES SINGLE PHASE
 3000-3600 rpm

Ex II 3D T100°C resp T135°C – IP66
 TÜV NORD Statement Conformity Number TUV 05 ATEX 2768X
 - Equipment and protective system intended for use in potentially explosive atmospheres (Zone 22) - Directive 94/9/EC
 - Compliance with Essential Health and Safety Requirements EN 61241-10



CE Declaration of conformity "type A" according to:
 - 73/23/EEC - 98/37/EEC - EN 60034-1
ETL Class II Div.2 Group FG - T6 - NEMA 4 conform to UL 1836 and CSA C22.2 N025
 Intertek ETL - SEMCO

TYPE	Mechanical Features						Electric Features									
	Working moment (*)		FC		Weight		Power		Current		Ia/In		II 3D Temp. Class Dust (°C)	Cable Glande	CAPACITOR	
	50Hz	60Hz	50Hz	60Hz	50Hz	60Hz	50 Hz	60 Hz	50Hz	60Hz	50Hz	60Hz			50Hz	60Hz
	Kgcm		Kg		Kg		Kw	A max (Y)	230V	115V			220V	115V		
MVE 60/3M	1.35	0.82	68	59	4.2	0.08	0.09	0.43	1.03	3.0	3.0	100	M16	3 µF	6,3 µF	
MVE 100/3M	2.01	1.52	101	110	4.6	0.1	0.11	0.54	1.3	3.0	3.0	100	M16	4 µF	8 µF	
MVE 200/3M	3.72	2.61	187	189	7.0	0.18	0.21	1.14	2.62	3,3	3.30	100	M20	8 µF	16 µF	
MVE 202/3M	3.72	2.61	187	189	7.2	0.18	0.21	1.14	2.62	3,3	3.30	100	M20	8 µF	16 µF	
MVE 300/3M	6.39	4.46	321	323	9.8	0.27	0.28	1.58	3.43	3.60	3.50	100	M20	12,5 µF	25 µF	

(*) = Working moment = 2 x static moment

TYPE	Dimensional Features																
	FIG.	Size	C (mm)		M (mm)		A (mm)	B (mm)	Ø G (mm)	Holes (n°)	D (mm)	E (mm)	F (mm)	H (mm)	I (mm)	L (mm)	N (mm)
			50Hz	60Hz	50Hz	60Hz	(mm)	(mm)	(mm)		(mm)	(mm)	(mm)	(mm)	(mm)	(mm)	(mm)
MVE 60/3M	A	10	211	45	*	*	*	4	130	136	12	48	94	121	85		
MVE 100/3M	A	10	211	45	*	*	*	4	130	136	12	48	94	121	85		
MVE 200/3M	B	20	219	41	62-74	106	9	4	131	159	15	64	121	123	112		
MVE 202/3M	G	23	218	53	**	**	**	4	164	140	25	82	116	159	110		
MVE 300/3M	C	30	260	43	***	***	***	4	154	175	15	79	142	163	131		

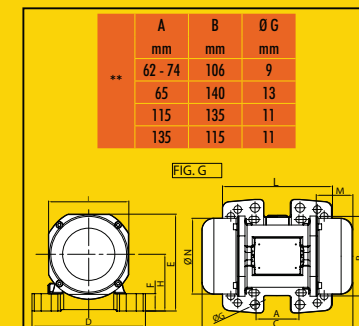
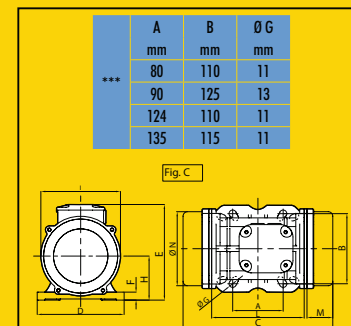
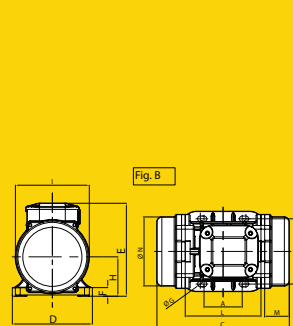
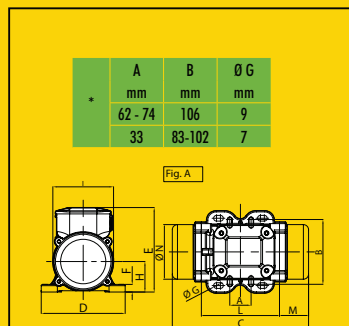
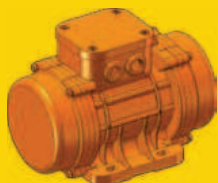

NOTE: Dimensions with coarse degree of accuracy related to UNI 22768/1



MVE - Standard Range
 ► MICRO MVE
 3000-3600 rpm

 IIBD T100°C resp. T135°C – IP66
 TUV NORD Statement Conformity Number TUV 05 ATEX 2768X
 - Equipment and protective system intended for use in potentially explosive atmospheres (Zone 22) - Directive 94/9/EC
 - Compliance with Essential Health and Safety Requirements EN 61241-10



 Declaration of conformity "type A" according to:
 - 73/23/EEC - 98/37/EEC - EN 60034-1
 Class II Div.2 Group FG - T6 - NEMA 4 conform to UL 1836 and CSA C22.2 NO25 Intertek ETL - SEMCO

THREE PHASE	Mechanical Features						Electric Features					
	Working moment (*)		FC		Weight		Power		Current			Cable
	Kgcm		Kg		Kg	Lb	Kw		A max			
	50Hz	60Hz	50Hz	60Hz	50Hz	50Hz	50 Hz	60 Hz	50 Hz	60 Hz	Dust	
MICRO 20/3	0.39	0.39	22	32	1.5	3.3	0.03	0.04	0.10	0.12	100	M16
MICRO 40/3	0.78	0.55	40	40	1.7	3.7	0.07	0.07	0.25	0.25	100	M16

(*) = Working moment = 2 x static moment

TYPE	Dimensional Features													
	FIG.	C	M	A	B	Ø G	Holes	D	E	F	H	I	L	N
		(mm)	(mm)	(mm)	(mm)	(mm)	n°	(mm)	(mm)	(mm)	(mm)	(mm)	(mm)	(mm)
MICRO 20/3	F	142	35	25-40	92	6.5	4	110	73	9	33	60	72	60
MICRO 40/3	F	162	45	25-40	92	6.5	4	110	73	9	33	60	72	60

NOTE: Dimensions with coarse degree of accuracy related to UNI 22768/1

SINGLE PHASE	Mechanical Features						Electric Features					
	Working moment (*)		FC		Weight		Power		Current			Cable
	Kgcm		Kg		Kg	Lb	Kw		A max			
	50Hz	60Hz	50Hz	60Hz	50Hz	50Hz	50 Hz	60 Hz	50 Hz	60 Hz	Dust	
MICRO 4/3 M	0.12	0.12	5	8	1.4	3.1	0.02	0.02	0.3	0.6	100	M16
MICRO 5/3 M	0.12	0.12	5	8	1.4	3.1	0.02	0.02	0.3	0.6	100	M16
MICRO 20/3 M	0.39	0.39	22	32	1.5	3.3	0.03	0.04	0.10	0.23	100	M16
MICRO 40/3 M	0.78	0.55	40	40	1.7	3.7	0.07	0.07	0.40	0.80	100	M16

(*) = Working moment = 2 x static moment

TYPE	Dimensional Features													
	FIG.	C	M	A	B	Ø G	Holes	D	E	F	H	I	L	N
		(mm)	(mm)	(mm)	(mm)	(mm)	n°	(mm)	(mm)	(mm)	(mm)	(mm)	(mm)	(mm)
MICRO 4/3 M	F	142	35	25-40	92	6.5	4	110	73	9	33	60	72	60
MICRO 5/3 M	F	142	35	25-41	75	5.5	4	90	73	9	33	60	72	60
MICRO 20/3 M	F	142	35	25-42	92	6.5	4	110	73	9	33	60	72	60
MICRO 40/3 M	F	162	45	25-43	92	6.5	4	110	73	9	33	60	72	60

NOTE: Dimensions with coarse degree of accuracy related to UNI 22768/1

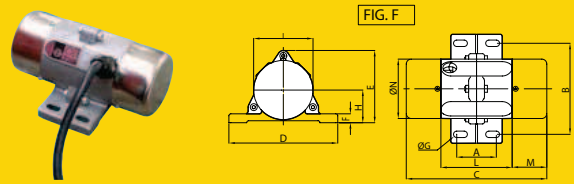

MVE - Standard Range
 ▶ DC
 3000 rpm

Ex IIBD T100°C resp T135°C – IP66
 TÜV NORD Statement Conformity Number TÜV 05 ATEX 2768X
 - Equipment and protective system intended for use in potentially explosive atmospheres (Zone 22) - Directive 94/9/EC
 - Compliance with Essential Health and Safety Requirements EN 61241-10



CE Declaration of conformity "type A" according to:
 - 73/23/EEC - 98/37/EEC - EN 60034-1

TYPE	Mechanical Features				Electric Features			
	RPM	Working moment (*) KgcM	FC Kg	Weight Kg	Power Kw	Current A max	Temp. Class Dust (°C)	Cable Glande
MVE 202 DC 24	3000	4.172	200	6.5	0.16	2	100	M20
MVE 202 DC 12	3000	4.172	200		0.16	4	100	M20
MVE 50 DC 24	3000	1.412	50	4.4	0.024	1	100	M16
MVE 50 DC 12	3000	1.612	51	4.4	0.024	2	100	M16

(*) = Working moment = 2 x static moment

TYPE	Dimensional Features														
	FIG.	Size	C (mm) 50Hz	M (mm) 50Hz	A	B	Ø G	Holes	D	E	F	H	I	L	N
					(mm)	(mm)	(mm)	n°	(mm)	(mm)	(mm)	(mm)	(mm)	(mm)	(mm)
MVE 202 DC 24	G	23	218	53	**	**	**	4	164	140	25	82	116	159	110
MVE 202 DC 12	G	23	218	53	**	**	**	4	164	140	25	82	116	159	110
MVE 50 DC 24	A	10	211	45	*	*	*	4	130	136	12	48	94	121	85
MVE 50 DC 12	A	10	211	45	*	*	*	4	130	136	12	48	94	121	85

NOTE: Dimensions with coarse degree of accuracy related to UNI 22768/1

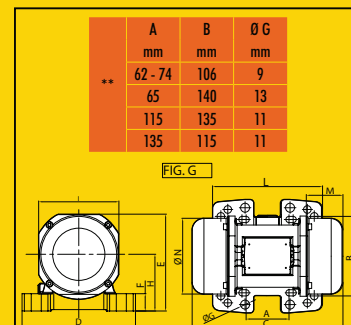
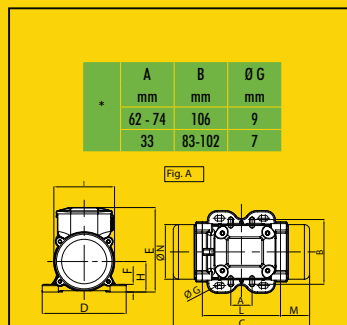

MVE-E Increased Safety Range

► 2 POLES
 3000-3600 rpm

Ex e II T3 Ex ID A21 T150°C IP66
 II 2 GD
 Certificate number Bassefa 06ATEX0281X/2
 Standard ref.: IEC60079-0; IEC60079-7; IEC61241-0; IEC61241-1
 IECEx BAS 06.0068X/2



CE Declaration of conformity "type A" according to:
 - 73/23/EEC - 98/37/EEC - EN 60034-1

TYPE	Mechanical Features						Electric Features										Cable Glande		
	Working moment (*)		FC		Weight		Power		Current				Ex						
	KgcM		Kg		Kg		Kw		A max (Y)				Ia/In		t _e			Temp. Class	
	50Hz	60Hz	50Hz	60Hz	50Hz	60Hz	50 Hz	60 Hz	50 Hz	60 Hz	50Hz	60Hz	50Hz	60Hz	Dust	Gas		T	
MVE 200/3E	3.72	2.61	187	189	7.0	0.18	0.21	0.35	0.35	3.3	3.30	18.0	18.0	150	T3	M20			
MVE 202/3E	3.72	2.61	187	189	7.2	0.18	0.21	0.35	0.35	3.3	3.30	18.0	18.0	150	T3	M20			
MVE 300/3E	6.39	4.46	321	323	9.8	0.27	0.28	0.52	0.45	3.60	3.50	14.0	14.0	150	T3	M20			
MVE 400/3E	7.96	5.68	407	411	10.3	0.30	0.36	0.58	0.60	3.50	3.50	15.0	15.0	150	T3	M20			
MVE 500/3E	10.27	7.38	530	534	15.8	0.50	0.58	0.96	0.97	4.00	4.20	12.0	11.0	150	T3	M20			
MVE 700/3E	14.90	10.57	758	765	16.5	0.66	0.75	1.25	1.24	4.30	5.00	11.0	8.0	150	T3	M20			
MVE 800/3E	15.68	11.06	794	800	20.6	0.75	0.90	1.45	1.50	3.80	3.80	12.0	12.0	150	T3	M20			
MVE 1200/3E	20.26	14.00	1005	1013	21.6	0.95	1.15	1.85	1.95	4.40	4.50	9.0	9.0	150	T3	M20			
MVE 1300/3E	27.58	18.86	1355	1365	22.0	1.30	1.38	2.44	2.25	5.20	5.00	7.5	8.0	150	T3	M20			
MVE 1301/3E	27.58	18.86	1355	1365	30.3	1.30	1.38	2.44	2.25	5.20	5.00	7.5	8.0	150	T3	M20			
MVE 1310/3E	22.34	22.34	1123	1616	30.0	1.30	1.38	2.44	2.25	5.20	5.00	7.5	8.0	150	T3	M20			
MVE 1600/3E	31.26	22.22	1601	1608	51.6	1.57	1.60	2.94	2.61	5.90	6.20	6.0	6.0	150	T3	M25			
MVE 2000/3E	36.78	27.60	2027	1997	52.0	2.00	2.10	3.75	3.42	6.50	6.40	5.5	5.5	150	T3	M25			
MVE 2300/3E	45.97	31.87	2302	2306	51.6	2.40	2.45	4.44	3.94	6.00	6.30	5.0	5.0	150	T3	M25			
MVE 3200/3E	68.10	43.89	3252	3176	101.4	2.90	2.90	5.30	4.61	8.30	8.20	5.0	5.0	150	T3	M32			
MVE 4000/3E	79.40	55.99	4033	4052	103.8	2.90	2.90	5.30	4.61	8.5	9.7	12.1	6.7	150	T3	M32			

(*) = Working moment = 2 x static moment

TYPE	FIG.	Size	Dimensional Features															
			C (mm)		M (mm)		A (mm)	B (mm)	Ø G (mm)	Holes (n°)	D (mm)	E (mm)	F (mm)	H (mm)	I (mm)	L (mm)	N (mm)	
			50Hz	60Hz	50Hz	60Hz												
MVE 200/3E	B	20	219	41	62-74	106	9	4	131	159	15	64	121	123	112			
MVE 202/3E	G	23	218	53	**	**	**	4	164	140	25	82	116	159	110			
MVE 300/3E	C	30	260	43	***	***	***	4	154	175	15	79	142	163	131			
MVE 400/3E	C	30	260	43	***	***	***	4	154	175	15	79	142	163	131			
MVE 500/3E	D	40	338	75	105	140	13	4	168	196	22	92	169	178	158			
MVE 700/3E	D	40	338	75	105	140	13	4	168	196	22	92	169	178	158			
MVE 800/3E	D	50	311	47	120	170	17	4	208	210	22	94	180	205	170			
MVE 1200/3E	D	50	311	47	120	170	17	4	208	210	22	94	180	205	170			
MVE 1300/3E	D	50	321	47	120	170	17	4	208	210	22	94	180	205	170			
MVE 1301/3E	D	53	321	47	100	180	17	4	236	210	26	98	180	205	170			
MVE 1310/3E	D	55	321	47	100	200	17	4	236	210	26	98	180	205	170			
MVE 1600/3E	D	60	418	83	140	190	17	4	229	247	30	120	247	220	222			
MVE 2000/3E	D	60	418	83	140	190	17	4	229	247	30	120	247	220	222			
MVE 2300/3E	D	60	418	83	140	190	17	4	229	247	30	120	247	220	222			
MVE 3200/3E	D	75	538	115	155	255	25	4	302	318	35	147	295	273	264			
MVE 4000/3E	D	75	538	115	155	255	25	4	302	318	35	147	295	273	264			

NOTE: Dimensions with coarse degree of accuracy related to UNI 22768/1

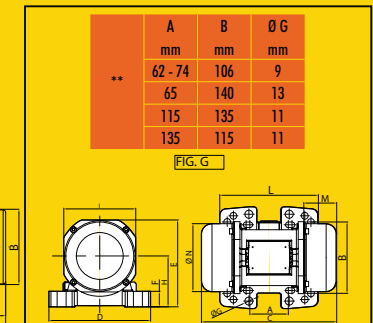
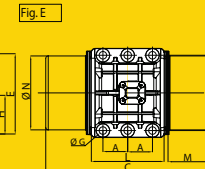
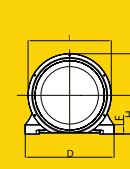
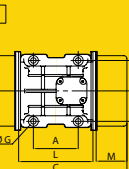
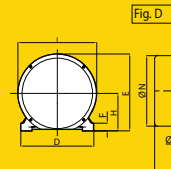
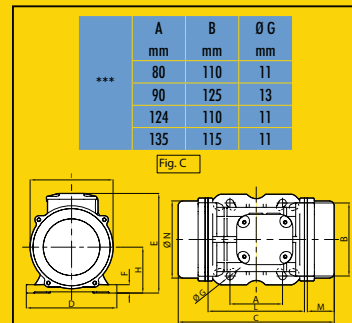
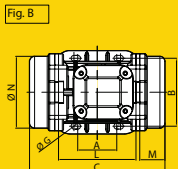
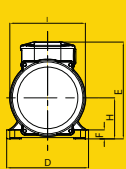
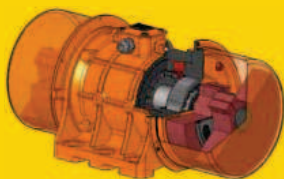

MVE-E Increased Safety Range
► 4 POLES
1500-1800 rpm

Ex e II T3 Ex tD A21 T150°C IP66
 II 2 GD
 Certificate number Bassefa 06ATEX0281X/2
 Standard ref.: IEC60079-0; IEC60079-7; IEC61241-0; IEC61241-1
 IECEx BAS 06.0068X/2



CE Declaration of conformity "type A" according to:
 - 73/23/EEC - 98/37/EEC - EN 60034-1

TYPE	Mechanical Features						Electric Features										Cable Glande
	Working moment (*)		FC		Weight		Power		Current		Ia/In		t _e		Temp. Class		
	Kgcm		Kg		Kg		Kw		A max (V)		50Hz		60Hz		Dust Gas		
	50Hz	60Hz	50Hz	60Hz	50Hz	60Hz	50 Hz	60 Hz	50 Hz	60 Hz	50Hz	60Hz	50Hz	60Hz	Dust	Gas	
MVE 200/15E	15.44	10.83	194	196	11.8		0.16	0.17	0.49	0.50	1.00	1.00	60	60	150	T3	M20
MVE 400/15E	33.43	23.38	420	423	19.5		0.30	0.35	0.84	0.86	2.50	2.50	30	30	150	T3	M20
MVE 500/15E	40.12	28.08	504	508	21.0		0.35	0.40	1.06	1.09	2.80	2.70	22	22	150	T3	M20
MVE 300/15E	26.58	18.60	334	336	22.5		0.62	0.73	1.32	1.41	3.00	3.20	20	19	150	T3	M20
MVE 700/15E	56.83	39.36	714	712	27.4		0.62	0.73	1.32	1.41	3.00	3.20	20	19	150	T3	M20
MVE 1100/15E	88.67	62.02	1114	1122	35.8		0.65	0.78	1.50	1.70	3.80	3.80	12	12	150	T3	M20
MVE 1400/15E	108.57	76.72	1364	1388	59.8		0.90	1.10	1.71	1.78	4.00	4.00	12	12	150	T3	M25
MVE 1700/15E	137.31	91.98	1725	1664	61.8		1.15	1.30	2.16	2.09	4.70	4.50	9	9	150	T3	M25
MVE 2400/15E	187.69	137.36	2358	2485	68.0		1.60	1.90	3.00	3.20	4.90	4.90	8	8	150	T3	M25
MVE 2500/15E	203.53	135.65	2557	2454	90.0		1.80	2.00	3.40	3.40	6.00	6.10	6	6	150	T3	M25
MVE 3000/15E	248.66	169.75	3124	3071	97.5		1.90	2.30	3.70	3.80	6.50	6.60	6	6	150	T3	M25
MVE 3800/15E	306.69	204.74	3853	3704	130.4	118.4	2.20	2.60	4.12	4.15	6.80	6.80	5	5	150	T3	M32
MVE 4300/15E	343.22	240.95	4312	4359	134.4	123.6	2.50	3.00	5.70	5.80	7.00	7.20	5	5	150	T3	M32
MVE 5500/15E	437.39	303.74	5495	5495	192.2	190.0	3.60	3.45	6.50	6.60	7.10	7.00	5	5	150	T3	M32

TYPE	Mechanical Features						Electric Features										Cable Glande
	Working moment (*)		FC		Weight		Power		Current		Ia/In		t _e		Temp. Class		
	Kgcm		Kg		Kg		Kw		A max (Δ)		50Hz		60Hz		Dust Gas		
	50Hz	60Hz	50Hz	60Hz	50Hz	60Hz	50 Hz	60 Hz	50 Hz	60 Hz	50Hz	60Hz	50Hz	60Hz	Dust	Gas	
MVE 7200/15E	576.76	397.32	7246	7188	253.0	246.6	5.00	6.00	9.60	9.41	6.80	6.90	5.00	5.00	150	T3	M32
MVE 9000/15E	717.97	498.76	9020	9023	268.6	257.8	7.50	8.50	12.00	12.00	7.00	7.00	5.00	5.00	150	T3	M32

(*) = Working moment = 2 x static moment

TYPE	Dimensional Features																
	FIG.	Size	C (mm)		M (mm)		A (mm)	B (mm)	Ø G (mm)	Holes n°	D (mm)	E (mm)	F (mm)	H (mm)	I (mm)	L (mm)	N (mm)
			50Hz	60Hz	50Hz	60Hz	(mm)	(mm)	(mm)		(mm)	(mm)	(mm)	(mm)	(mm)	(mm)	(mm)
MVE 200/15E	C	30	260	43	***	***	***	4	154	175	15	79	142	163	131		
MVE 400/15E	D	40	338	75	105	140	13	4	168	196	22	92	169	178	158		
MVE 500/15E	D	40	338	75	105	140	13	4	168	196	22	92	169	178	158		
MVE 300/15E	D	50	311	47	120	170	17	4	208	210	22	94	180	205	170		
MVE 700/15E	D	50	397	90	120	170	17	4	208	210	22	94	180	205	170		
MVE 1100/15E	D	50	451	112	120	170	17	4	208	210	22	94	180	205	170		
MVE 1400/15E	D	60	448	98	140	190	17	4	229	247	30	120	247	220	222		
MVE 1700/15E	D	60	448	98	140	190	17	4	229	247	30	120	247	220	222		
MVE 2400/15E	D	60	510	448	129	98	140	190	17	4	229	247	30	120	247	220	222
MVE 2500/15E	D	70	522	486	123	105	155	225	22	4	272	284	40	140	267	250	235
MVE 3000/15E	D	70	522	486	123	105	155	225	22	4	272	284	40	140	267	250	235
MVE 3800/15E	D	75	588	538	140	115	155	255	23.5	4	302	318	35	147	295	273	264
MVE 4300/15E	D	75	588	140	155	255	23.5	4	302	318	35	147	295	273	264		
MVE 5500/15E	D	80	603	130	180	280	26	4	332	360	37	167	345	304	310		

TYPE	Dimensional Features																
	FIG.	Size	C (mm)		M (mm)		A (mm)	B (mm)	Ø G (mm)	Holes n°	D (mm)	E (mm)	F (mm)	H (mm)	I (mm)	L (mm)	N (mm)
			50Hz	60Hz	50Hz	60Hz	(mm)	(mm)	(mm)		(mm)	(mm)	(mm)	(mm)	(mm)	(mm)	(mm)
MVE 7200/15E	D	85	605	120	200	320	28	4	385	410	49	200	422	325	378		
MVE 9000/15E	D	85	605	120	200	320	28	4	385	410	49	200	422	325	378		

NOTE: Dimensions with coarse degree of accuracy related to UNI 22768/1

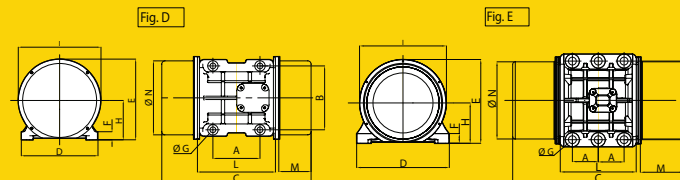
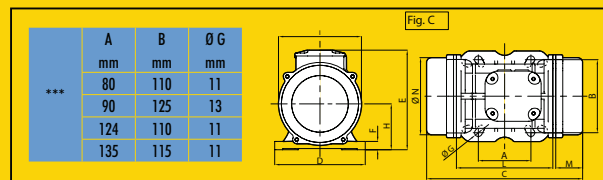
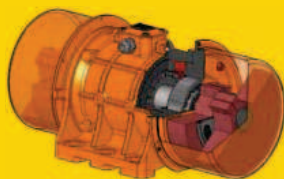

MVE-E Increased Safety Range

► 6 POLES

1000-1200 rpm

Ex II T3 Ex d A21 T150°C IP66
 II 2 GD
 Certificate number Bassefa 06ATEX0281X/2
 Standard ref.: IEC60079-0; IEC60079-7; IEC61241-0; IEC61241-1
 IECEx BAS 06.0068X/2



CE Declaration of conformity "type A" according to:
 - 73/23/EEC - 98/37/EEC - EN 60034-1

TYPE	Mechanical Features						Electric Features										Cable Glande		
	Working moment		FC		Weight		Power				Current		Ex						
	Kg		Kg		Kg		Kw		Hp		A max (V)		Ia/In		t _e			Temp. Class	
	50Hz	60Hz	50Hz	60Hz	50Hz	60Hz	50 Hz	60 Hz	50 Hz	60 Hz	50Hz	60Hz	50Hz	60Hz	50Hz	60Hz		Dust	Gas
MVE 50/1E	9.49	6.59	53	53	10.4	0.12	0.14	0.16	0.19	0.40	0.40	1.00	1.00	60.0	60.0	150	T3	M20	
MVE 100/1E	18.80	13.18	105	106	12.2	0.12	0.14	0.16	0.19	0.40	0.40	1.00	1.00	60.0	60.0	150	T3	M20	
MVE 200/1E	33.49	23.38	187	188	19.6	0.18	0.21	0.24	0.28	0.53	0.51	1.00	1.00	60.0	60.0	150	T3	M20	
MVE 300/1E	47.82	33.46	267	269	26.6	0.35	0.38	0.47	0.51	0.67	0.64	2.50	2.50	30.0	30.0	150	T3	M20	
MVE 500/1E	91.88	64.32	513	517	34.0	0.35	0.40	0.47	0.54	1.20	1.15	2.80	2.70	24.0	24.0	150	T3	M20	
MVE 510/1E	91.88	91.88	513	739	34.5	0.35	0.40	0.47	0.54	1.20	1.15	2.80	2.70	24.0	24.0	150	T3	M20	
MVE 800/1E	137.37	108.58	767	873	61.8	0.68	0.76	0.91	1.02	1.29	1.26	2.80	2.80	24.0	24.0	150	T3	M25	
MVE 1100/1E	187.69	137.31	1048	1104	79.4	0.75	0.80	1.01	1.07	1.42	1.32	3.20	3.10	19.0	19.0	150	T3	M25	
MVE 1500/1E	284.76	196.51	1590	1580	83.6	1.10	1.30	1.48	1.74	2.10	2.00	3.30	3.30	16.0	16.0	150	T3	M25	
MVE 1600/1E	299.63	203.47	1673	1636	99.8	1.10	1.30	1.48	1.74	2.83	3.22	3.70	3.60	13.0	13.0	150	T3	M25	
MVE 2100/1E	373.05	248.74	2083	2000	114.3	1.50	1.80	2.01	2.41	3.00	3.00	4.30	4.40	10.0	10.0	150	T3	M25	
MVE 2600/1E	467.44	306.70	2610	2466	148.6	1.96	2.10	2.63	2.82	3.63	3.38	4.80	4.80	9.0	9.0	150	T3	M32	
MVE 3000/1E	540.33	379.71	3017	3053	155.4	2.20	2.40	2.95	3.22	4.50	4.30	5.00	5.00	8.0	8.0	150	T3	M32	
MVE 3800/1E	680.38	437.41	3799	3517	215.6	2.50	3.00	3.35	4.02	4.67	4.88	5.90	6.00	6.0	6.0	150	T3	M32	
MVE 4700/1E	838.34	584.17	4681	4697	230.8	3.20	3.90	4.29	5.23	6.50	6.00	5.50	5.70	7.0	7.0	150	T3	M32	
MVE 5200/1E	929.86	654.57	5192	5263	279.8	3.80	4.00	5.10	5.36	6.92	6.36	5.50	5.50	7.0	7.0	150	T3	M32	
MVE 6500/1E	1165.19	823.96	6506	6625	304.4	4.30	5.00	5.77	6.71	7.76	7.81	6.20	6.00	6.0	6.0	150	T3	M32	

TYPE	Mechanical Features						Electric Features										Cable Glande		
	Working moment		FC		Weight		Power				Current		Ex						
	Kg		Kg		Kg		Kw		Hp		A max (Δ)		Ia/In		t _e			Temp. Class	
	50Hz	60Hz	50Hz	60Hz	50Hz	60Hz	50 Hz	60 Hz	50 Hz	60 Hz	50Hz	60Hz	50Hz	60Hz	50Hz	60Hz		Dust	Gas
MVE 8000/1E	1435.98	929.80	8018	7476	325.2	7.10	7.50	9.52	10.06	12.60	11.60	6.00	6.20	6.0	6.0	150	T3	M32	
MVE 9000/1E	1600.39	1165.23	8936	9369	337.8	7.50	8.30	10.06	11.13	13.20	12.60	6.30	6.20	5.5	5.5	150	T3	M32	
MVE 10000/1E	1788.44	1239.98	9986	9970	385.8	7.60	8.00	10.19	10.73	13.50	12.70	6.40	6.40	5.5	5.5	150	T3	M32	

(*) = Working moment = 2 x static moment

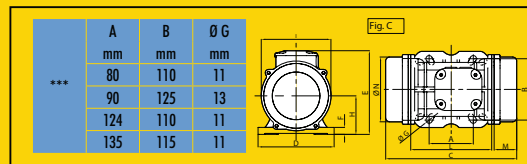

TYPE	FIG.	Size	Dimensional Features														
			C (mm)		M (mm)		A (mm)	B (mm)	Ø G (mm)	Holes n°	D (mm)	E (mm)	F (mm)	H (mm)	I (mm)	L (mm)	N (mm)
			50Hz	60Hz	50Hz	60Hz											
MVE 50/1E	C	30	260	43	***	***	***	4	154	175	15	79	142	163	131		
MVE 100/1E	C	30	300	63	***	***	***	4	154	175	15	79	142	163	131		
MVE 200/1E	D	40	338	75	105	140	13	4	168	196	22	92	169	178	158		
MVE 300/1E	D	50	397	90	120	170	17	4	208	210	22	94	180	205	170		
MVE 500/1E	D	50	441	112	120	170	17	4	208	210	22	94	180	205	170		
MVE 510/1E	D	50	451	112	120	170	17	4	208	210	22	94	180	205	170		
MVE 800/1E	D	60	448	98	140	190	17	4	229	247	30	120	247	220	222		
MVE 1100/1E	D	60	510	448	129	98	140	190	17	4	229	247	30	120	247	220	222
MVE 1500/1E	D	60	562	510	154	129	140	190	17	4	229	247	30	120	247	220	222
MVE 1600/1E	D	70	556	522	140	123	155	225	22	4	272	284	40	140	267	250	235
MVE 2100/1E	D	70	616	522	170	123	155	225	22	4	272	284	40	140	267	250	235
MVE 2600/1E	D	75	708	588	200	140	155	255	23.5	4	302	318	35	147	295	273	264
MVE 3000/1E	D	75	708	608	200	150	155	255	23.5	4	302	318	35	147	295	273	264
MVE 3800/1E	D	80	683	603	170	130	180	280	26	4	332	360	37	167	345	304	310
MVE 4700/1E	D	80	733	683	195	170	180	280	26	4	332	360	37	167	345	304	310
MVE 5200/1E	D	85	685	605	160	120	200	320	28	4	385	410	49	200	422	325	378
MVE 6500/1E	D	85	685	605	160	120	200	320	28	4	385	410	49	200	422	325	378

TYPE	FIG.	Size	Dimensional Features														
			C (mm)		M (mm)		A (mm)	B (mm)	Ø G (mm)	Holes n°	D (mm)	E (mm)	F (mm)	H (mm)	I (mm)	L (mm)	N (mm)
			50Hz	60Hz	50Hz	60Hz											
MVE 8000/1E	D	85	785	685	210	160	200	320	28	4	385	410	49	200	422	325	378
MVE 9000/1E	D	85	785	685	210	160	200	320	28	4	385	410	49	200	422	325	378
MVE 10000/1E	E	90	826	210	125	380	38	6	452	430	44	204	422	367	378		

NOTE: Dimensions with coarse degree of accuracy related to UNI 22768/1

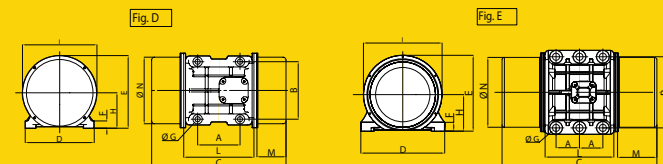

MVE-E Increased Safety Range
► 8 POLES
750-900 rpm

Ex II T3 Ex tD A21 T150°C IP66
 II 2 GD
 Certificate number Baseefa 06ATEX0281X/2
 Standard ref.: IEC60079-0; IEC60079-7; IEC61241-0; IEC61241-1
 IECEx BAS 06.0068X/2



CE Declaration of conformity "type A" according to:
 - 73/23/EEC - 98/37/EEC - EN 60034-1

TYPE	Mechanical Features				Electric Features										Cable Glande		
	Working moment (*)		FC		Weight		Power		Current		Ex						
	Kgcm		Kg		Kg		Kw		A max (Y)		Ia/In		t _e			Temp. Class	
	50Hz - 60Hz		50Hz	60Hz	50Hz - 60Hz		50 Hz	60 Hz	50 Hz	60 Hz	50Hz	60Hz	50Hz	60Hz		Dust	Gas
MVE 150/075E	33.39	105	151	21.4	0.23	0.25	1.14	1.14	1.50	1.50	30.0	30.0	150	T3	M20		
MVE 250/075E	57.27	180	259	29.5	0.35	0.38	1.15	1.15	1.70	1.70	30.0	30.0	150	T3	M20		
MVE 400/075E	84.02	264	380	35.0	0.35	0.38	1.15	1.15	1.90	1.90	30.0	30.0	150	T3	M20		
MVE 650/075E	137.31	431	621	64.7	0.50	0.60	1.20	1.20	2.20	2.20	30.0	30.0	150	T3	M25		
MVE 900/075E	187.72	589	849	71.0	0.65	0.78	1.23	1.29	2.50	2.50	25.0	25.0	150	T3	M25		
MVE 1300/075E	299.60	941	1355	99.8	1.00	1.10	1.86	1.83	3.00	3.00	20.0	20.0	150	T3	M25		
MVE 2100/075E	467.41	1468	2114	150.4	1.50	1.80	2.81	2.89	4.20	4.10	12.0	12.0	150	T3	M32		
MVE 3100/075E	680.34	2137	3077	212.2	2.00	2.30	3.79	3.77	4.00	4.00	12.0	12.0	150	T3	M32		
MVE 3800/075E	838.43	2633	3792	230.2	2.50	3.00	6.00	6.00	3.90	4.00	12.0	12.0	150	T3	M32		
MVE 4200/075E	929.74	2920	4205	284.5	2.90	3.40	6.50	6.50	3.80	3.70	13.0	13.0	150	T3	M32		
MVE 5300/075E	1165.22	3660	5270	305	4.00	4.30	8.50	8.00	3.80	4.20	13.0	12.0	150	T3	M32		
MVE 6500/075E	1435.85	4510	6494	324.4	5.00	5.90	10.00	10.00	3.60	4.00	14.0	12.0	150	T3	M32		

TYPE	Mechanical Features				Electric Features										Cable Glande		
	Working moment (*)		FC		Weight		Power		Current		Ex						
	Kgcm		Kg		Kg		Kw		A max (Δ)		Ia/In		t _e			Temp. Class	
	50Hz - 60Hz		50Hz	60Hz	50Hz - 60Hz		50 Hz	60 Hz	50 Hz	60 Hz	50Hz	60Hz	50Hz	60Hz		Dust	Gas
MVE 10000/075E	2200.43	6911	9952	422.2	6.80	7.50	13.50	12.5	3.5	4.2	24.8	22.8	150	T3	M32		

(*) = Working moment = 2 x static moment

TYPE	Dimensional Features														
	FIG.	Size	C	M	A	B	Ø G	Holes	D	E	F	H	I	L	N
			(mm)	(mm)	(mm)	(mm)	(mm)	n°	(mm)	(mm)	(mm)	(mm)	(mm)	(mm)	(mm)
MVE 150/075E	D	40	338	75	105	140	13	4	168	196	22	92	169	178	158
MVE 250/075E	D	50	397	90	120	170	17	4	208	210	22	94	180	205	170
MVE 400/075E	D	50	441	112	120	170	17	4	208	210	22	94	180	205	170
MVE 650/075E	D	60	448	98	140	190	17	4	229	247	30	120	247	220	222
MVE 900/075E	D	60	510	129	140	190	17	4	229	247	30	120	247	220	222
MVE 1300/075E	D	70	556	140	155	225	22	4	272	284	40	140	267	250	235
MVE 2100/075E	D	75	708	200	155	255	23.5	4	302	318	35	147	295	273	264
MVE 3100/075E	D	80	683	170	180	280	26	4	332	360	37	167	345	304	310
MVE 3800/075E	D	80	733	195	180	280	26	4	332	360	37	167	345	304	310
MVE 4200/075E	D	85	685	160	200	320	28	4	385	410	49	199	422	325	378
MVE 5300/075E	D	85	685	160	200	320	28	4	385	410	49	199	422	325	378
MVE 6500/075E	D	85	785	210	200	320	28	4	385	410	49	199	422	325	378

TYPE	Dimensional Features														
	FIG.	Size	C	M	A	B	Ø G	Holes	D	E	F	H	I	L	N
			(mm)	(mm)	(mm)	(mm)	(mm)	n°	(mm)	(mm)	(mm)	(mm)	(mm)	(mm)	(mm)
MVE 10000/075E	E	90	926	260	125	380	38	6	452	430	44	204	422	367	378

NOTE: Dimensions with coarse degree of accuracy related to UNI 22768/1

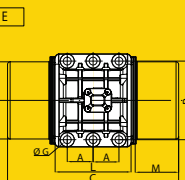
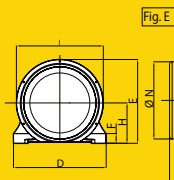
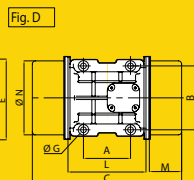
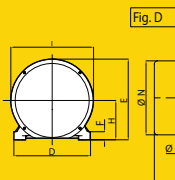
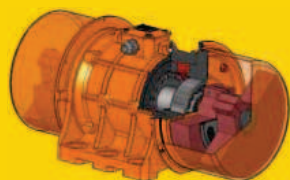

MVE-D Explosion Proof Range
► 2 POLES
3000-3600 rpm

II2 GD Exd IIB T4 Ex tD A21 IP66 T135°C
 Ex d IIB T4 Gb; Ex tD A21 IIC T135°C Db IP66
 Cert. no.: TUV 08 ATEX 362386 X
 Standard ref.: IEC60079-0; IEC60079-1; IEC61241-1 ExI2GD
 Cert. no.: IECEx TUN 08.0012X



CE Declaration of conformity "type A" according to:
 - 73/23/EEC - 98/37/EEC - EN 60034-1

TYPE	Mechanical Features						Electric Features								Cable Glande
	Working moment (*) Kgcm		FC Kg		Weight Kg		Power Kw		Current A max (Y)		Ia/In		Ex		
	50Hz	60Hz	50Hz	60Hz	50Hz	60Hz	50 Hz	60 Hz	50 Hz	60 Hz	50Hz	60Hz	Dust (°C)	Gas T	
MVE 800/3D	15.68	11.06	794	800	29.0		0.75	0.90	1.45	1.50	3.80	3.80	135	T4	M20
MVE 1300/3D	27.58	18.86	1355	1365	30.4		1.30	1.38	2.44	2.25	5.20	5.00	135	T4	M20
MVE 1600/3D	31.26	22.22	1601	1608	60.0	59.6	1.57	1.60	2.94	2.61	5.90	6.20	135	T4	M25
MVE 2000/3D	36.78	27.60	2027	1997	61.2	60.4	2.00	2.10	3.75	3.42	6.50	6.40	135	T4	M25
MVE 2300/3D	45.97	31.87	2302	2306	62.0	60.0	2.40	2.45	4.44	3.94	6.00	6.30	135	T4	M25
MVE 3200/3D	68.10	43.89	3252	3176	111.4	109.8	2.90	2.90	5.30	4.61	8.30	8.20	135	T4	M32
MVE 4000/3D	79.40	55.99	4033	4052	115.4	111.4	2.90	2.90	5.30	4.61	8,5	9,7	135	T4	M32

(*) = Working moment = 2 x static moment

TYPE	Dimensional Features														
	FIG.	Size	C (mm) 50Hz - 60 Hz	M (mm) 50Hz - 60 Hz	A	B	Ø G	Holes	D	E	F	H	I	L	N
					(mm)	(mm)	(mm)	n°	(mm)	(mm)	(mm)	(mm)	(mm)	(mm)	(mm)
MVE 800/3D	A	50	335	65	120	170	17	4	209	229	28	103	195	205	166.5
MVE 1300/3D	A	50	335	65	120	170	17	4	209	229	28	103	195	205	166.5
MVE 1600/3D	A	60	478	103	140	190	17	4	234	267	31	124	188	234	222
MVE 2000/3D	A	60	478	103	140	190	17	4	234	267	31	124	188	234	222
MVE 2300/3D	A	63	478	103	140	190	22	4	234	267	31	124	188	234	222
MVE 3200/3D	A	75	593	127	155	255	23.5	4	300	321	35	147	235	298	265
MVE 4000/3D	A	75	593	127	155	255	23.5	4	300	321	35	147	235	298	265

NOTE: Dimensions with coarse degree of accuracy related to UNI 22768/1

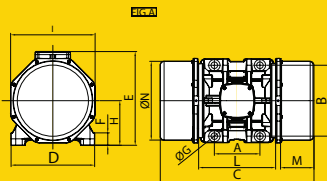
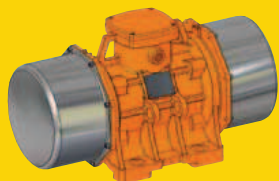

MVE-D Explosion Proof Range
 ► 4 POLES
 1500-1800 rpm

II2 GD Exd IIB T4 Ex tD A21 IP66 T135°C
 Ex d IIB T4 Gb; Ex tD A21 IIIC T135°C Db IP66
 Cert. no: TUV 08 ATEX 362386 X
 Standard ref.: IEC60079-0; IEC60079-1; IEC61241-1 ExI2GD
 Cert. no: IECEx TUN 08.0012X



CE Declaration of conformity "type A" according to:
 - 73/23/EEC - 98/37/EEC - EN 60034-1

TYPE	Mechanical Features						Electric Features											Cable Glande
	Working moment		FC		Weight		Power				Current		Ia/In		Ex			
	KgcM		Kg		Kg		Kw		Hp		A max (Y)		50Hz		60Hz			
	50Hz	60Hz	50Hz	60Hz	50Hz	60Hz	50 Hz	60 Hz	50 Hz	60 Hz	50 Hz	60 Hz	50Hz	60Hz	Dust	Gas		
										400V		460V				(°C)	T	
MVE 700/15D	56.83	39.36	714	712	35.8	0.62	0.73	0.83	0.98	1.32	1.41	3.00	3.20	135	T4	M20		
MVE 1100/15D	88.67	62.02	1114	1122	44.2	0.65	0.78	0.87	1.05	1.50	1.70	3.80	3.80	135	T4	M20		
MVE 1400/15D	108.57	76.72	1364	1388	68.2	0.90	1.10	1.21	1.48	1.71	1.78	4.00	4.00	135	T4	M25		
MVE 1700/15D	137.31	91.98	1725	1664	70.2	1.15	1.30	1.54	1.74	2.16	2.09	4.70	4.50	135	T4	M25		
MVE 2400/15D	187.69	137.36	2358	2485	76.4	1.60	1.90	2.15	2.55	3.00	3.20	4.90	4.90	135	T4	M25		
MVE 2500/15D	203.53	135.65	2557	2454	98.4	1.80	2.00	2.41	2.68	3.40	3.40	6.00	6.10	135	T4	M25		
MVE 3000/15D	248.66	169.75	3124	3071	105.9	1.90	2.30	2.55	3.08	3.70	3.80	6.50	6.60	135	T4	M25		
MVE 3800/15D	306.69	204.74	3853	3704	138.4	2.20	2.60	2.95	3.49	4.12	4.15	6.80	6.80	135	T4	M32		
MVE 3810/15D	306.69	204.74	3853	3704	140.5	2.20	2.60	2.95	3.49	4.12	4.15	6.80	6.80	135	T4	M32		
MVE 4300/15D	343.22	240.95	4312	4359	142.8	2.50	3.00	3.35	4.02	5.70	5.80	7.00	7.20	135	T4	M32		
MVE 5500/15D	437.39	303.74	5495	5495	200.6	3.60	3.45	4.83	4.63	6.50	6.60	7.10	7.00	135	T4	M32		

(*) = Working moment = 2 x static moment

TYPE	Dimensional Features																
	FIG.	Size	C		M		A	B	Ø G	Holes	D	E	F	H	I	L	N
			50Hz	60Hz	50Hz	60Hz											
MVE 700/15D	A	50	393	94	120	170	17	4	209	240	28	103	195	205	167		
MVE 1100/15D	A	50	457	126	120	170	17	4	209	240	28	103	195	205	167		
MVE 1400/15D	A	60	478	105	140	190	17	4	234	267	31	124	188	230	222		
MVE 1700/15D	A	63	478	105	140	190	22	4	234	267	31	124	188	230	222		
MVE 2400/15D	A	63	512	478	122	105	140	190	22	4	234	267	31	124	188	230	222
MVE 2500/15D	A	70	556	130	155	255	22	4	274	309	35	140	215	264	236		
MVE 3000/15D	A	70	556	130	155	255	22	4	274	309	35	140	215	264	236		
MVE 3800/15D	A	75	593	127	155	255	23.5	4	300	321	35	147	235	298	265		
MVE 3810/15D	B	77	593	127	105	248	22	6	298	321	35	147	235	298	265		
MVE 4300/15D	A	75	629	593	145	127	155	255	23.5	4	300	321	35	147	235	298	236
MVE 5500/15D	A	80	607	132	180	280	26	4	330	370	50	176	293	304	311		

NOTE: Dimensions with coarse degree of accuracy related to UNI 22768/1

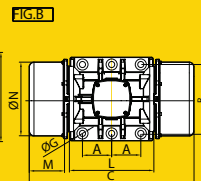
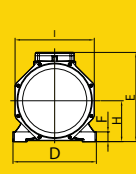
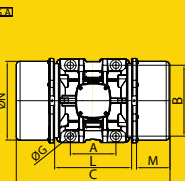
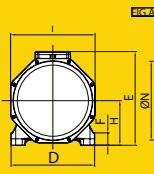
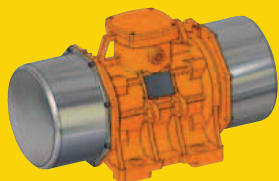

MVE-D Explosion Proof Range

► 6 POLES

1000-1200 rpm

II2 GD Exd IIB T4 Ex tD A21 IP66 T135°C
 Ex d IIB T4 Gb; Ex tD A21 IIIC T135°C Db IP66
 Cert. no: TUV 08 ATEX 362386 X
 Standard ref.: IEC60079-0; IEC60079-1; IEC61241-1 ExI2GD
 Cert. no: IECEx TUN 08.0012X



CE Declaration of conformity "type A" according to:
 - 73/23/EEC - 98/37/EEC - EN 60034-1

TYPE	Mechanical Features						Electric Features										Cable Glande
	Working moment		FC		Weight		Power				Current		Ia/In		Ex		
	Kgcm		Kg		Kg		Kw		Hp		A max (Y)		50Hz		60Hz		
	50Hz	60Hz	50Hz	60Hz	50Hz	60Hz	50 Hz	60 Hz	50 Hz	60 Hz	50 Hz	60 Hz	50Hz	60Hz	Dust (°C)	Gas T	
MVE 500/1D	85	60	475	479	34.0		0.4	0.4	0.5	0.5	1.2	1.2	2.8	2.7	135	T4	M20
MVE 800/1D	137	109	767	873	70.2	67.8	0.7	0.8	0.9	1.0	1.3	1.3	2.8	2.8	135	T4	M25
MVE 1100/1D	188	137	1048	1104	87.8	81.4	0.8	0.8	1.0	1.1	1.4	1.3	3.2	3.1	135	T4	M25
MVE 1500/1D	285	197	1590	1580	92.0	84.9	1.1	1.3	1.5	1.7	2.1	2.0	3.3	3.3	135	T4	M25
MVE 1600/1D	300	203	1673	1636	108.4	97.4	1.1	1.3	1.5	1.7	2.8	3.2	3.7	3.6	135	T4	M25
MVE 2100/1D	373	249	2083	2000	122.7	108.9	1.5	1.8	2.0	2.4	3.0	3.0	4.3	4.4	135	T4	M25
MVE 2600/1D	467	307	2610	2466	157.0	139.9	2.0	2.1	2.6	2.8	3.6	3.4	4.8	4.8	135	T4	M32
MVE 3000/1D	540	380	3017	3053	163.8	146.2	2.2	2.4	3.0	3.2	4.5	4.3	5.0	5.0	135	T4	M32
MVE 3800/1D	680	437	3799	3517	224.0	203.2	2.5	3.0	3.4	4.0	4.7	4.9	5.9	6.0	135	T4	M32
MVE 4700/1D	838	584	4681	4697	239.2	220.8	3.2	3.9	4.3	5.2	6.5	6.0	5.5	5.7	135	T4	M32

(*) = Working moment = 2 x static moment

TYPE	Dimensional Features																
	FIG.	Size	C (mm)		M (mm)		A (mm)	B (mm)	Ø G (mm)	Holes n°	D (mm)	E (mm)	F (mm)	H (mm)	I (mm)	L (mm)	N (mm)
			50Hz	60Hz	50Hz	60Hz											
MVE 500/1D	A	50	457		126	120	170	17	4	209	240	28	103	195	205	167	
MVE 800/1D	A	60	478		105	140	190	17	4	234	267	31	124	188	230	222	
MVE 1100/1D	A	63	512	478	122	105	140	190	22	4	234	267	31	124	188	230	222
MVE 1500/1D	A	60	588	512	160	122	140	190	17	4	234	267	31	124	188	230	222
MVE 1600/1D	A	70	596	556	150	130	155	225	22	4	274	309	35	140	215	264	206
MVE 2100/1D	A	70	652	596	178	150	155	225	22	4	274	309	35	140	215	264	206
MVE 2600/1D	A	75	675	593	168	127	155	225	23.5	4	300	321	35	147	235	304	265
MVE 3000/1D	A	75	715	629	188	145	155	225	23.5	4	300	321	35	147	235	304	265
MVE 3800/1D	A	80	693	607	175	132	180	280	26	4	330	370	48.86	176	293	304	311
MVE 4700/1D	A	80	743	693	200	175	180	280	26	4	330	370	48.86	176	293	304	311

NOTE: Dimensions with coarse degree of accuracy related to UNI 22768/1

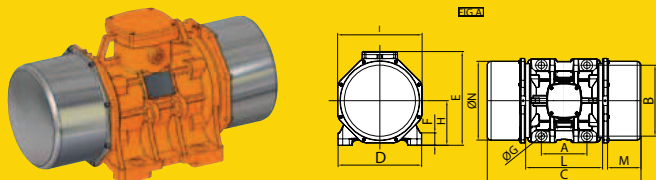

MVE-D Explosion Proof Range
► 8 POLES
750-900 rpm

II2 GD Exd IIB T4 Ex ID A21 IP66 T135°C
 Ex d IIB T4 Gb; Ex ID A21 IIC T135°C Db IP66
 Cert. no.: TUV 08 ATEX 362386 X
 Standard ref.: IEC60079-0; IEC60079-1; IEC61241-1 ExI2GD
 Cert. no.: IECEx TUN 08.0012X



CE Declaration of conformity "type A" according to:
 - 73/23/EEC - 98/37/EEC - EN 60034-1

TYPE	Mechanical Features					Electric Features								Cable Glande
	Working moment (*) Kgcm 50Hz - 60Hz	FC		Weight		Power		Current		Ia/In		Ex		
		50Hz	60Hz	Kg	Lb	50 Hz	60 Hz	50 Hz	60 Hz	50Hz	60Hz	Dust	Gas	
MVE 250/075D	57.27	180	259	37.9	83.6	0.35	0.38	1.15	1.15	1.70	1.70	135	T4	M20
MVE 400/075D	84.02	264	380	43.4	95.7	0.35	0.38	1.15	1.15	1.90	1.90	135	T4	M20
MVE 650/075D	137.31	431	621	73.1	161.2	0.50	0.60	1.20	1.20	2.20	2.20	135	T4	M25
MVE 900/075D	187.72	589	849	79.4	175.0	0.65	0.78	1.23	1.29	2.50	2.50	135	T4	M25
MVE 1300/075D	299.60	941	1355	108.2	238.5	1.00	1.10	1.86	1.83	3.00	3.00	135	T4	M25
MVE 2100/075D	467.41	1468	2114	158.8	350.1	1.50	1.80	2.81	2.89	4.20	4.10	135	T4	M32
MVE 3100/075D	680.34	2137	3077	220.6	486.3	2.00	2.30	3.79	3.77	4.00	4.00	135	T4	M32
MVE 3800/075D	838.43	2633	3792	238.6	526.0	2.50	3.00	6.00	6.00	3.90	4.00	135	T4	M32

(*) = Working moment = 2 x static moment

TYPE	Dimensional Features															
	FIG.	Size	C (mm) 50Hz - 60 Hz	M (mm) 50Hz - 60 Hz	A (mm)	B (mm)	Ø G (mm)	Holes n°	D (mm)	E (mm)	F (mm)	H (mm)	I (mm)	L (mm)	N (mm)	
MVE 250/075D	A	50	393	94	120	170	17	4	209	240	28.1	103	195	205	167	
MVE 400/075D	A	50	457	126	120	170	17	4	209	240	28.1	103	195	205	167	
MVE 650/075D	A	60	478	105	140	190	17	4	234	267	31	124	188	230	222	
MVE 900/075D	A	63	512	122	140	190	22	4	234	267	31	124	188	230	222	
MVE 1300/075D	A	70	596	150	155	225	22	4	274	309	35	140	215	264	236	
MVE 2100/075D	A	75	675	168	155	255	23.5	4	300	321	35	147	235	298	265	
MVE 3100/075D	A	80	693	175	180	280	26	4	330	370	48.86	176	293	304	311	
MVE 3800/075D	A	80	743	200	180	280	26	4	330	370	48.86	176	293	304	311	

NOTE: Dimensions with coarse degree of accuracy related to UNI 22768/1

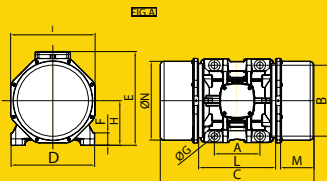
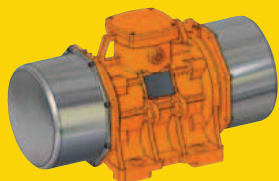

MVE-S with split covers

► 4 POLES

1500-1800 rpm

II3D T100°C resp T135°C – IP65
 TUV NORD Statement Conformity Number TUV 05 ATEX 2768X
 - Equipment and protective system intended for use in potentially explosive atmospheres (Zone 22) - Directive 94/9/EC
 - Compliance with Essential Health and Safety Requirements
 EN 61241-10



Declaration of conformity "Type A" according to:
 - 73/23/EEC - 98/37/EEC - EN 60034-1

TYPE	Mechanical Features						Electric Features								Cable
	Working moment (*)		FC		Weight		Power		Current		Ia/In		Temp. Class	Glande	
	Kgcm		Kg		Kg		Kw		A max (V)						
	50Hz	60Hz	50Hz	60Hz	50Hz	60Hz	50 Hz	60 Hz	50Hz	60Hz	50Hz	60Hz	Dust		
												(°C)			
MVE 1400/15S	108.57	76.72	1364	1388	59.8	58.2	0.90	1.10	1.71	1.78	4.00	4.00	135	M25	
MVE 1700/15S	137.31	91.98	1725	1664	61.8	59.4	1.15	1.30	2.16	2.09	4.70	4.50	135	M25	
MVE 2400/15S	187.69	137.36	2358	2485	68.0	62.0	1.60	1.90	3.00	3.20	4.90	4.90	135	M25	
MVE 3800/15S	306.69	204.74	3853	3704	130.4	118.4	2.20	2.60	4.12	4.15	6.80	6.80	135	M32	
MVE 4300/15S	343.22	240.95	4312	4359	134.4	123.6	2.50	3.00	5.70	5.80	7.00	7.20	135	M32	
MVE 5500/15S	437.39	303.74	5495	5495	192.2	190.0	3.60	3.45	6.50	6.60	7.10	7.00	135	M32	

TYPE	Mechanical Features						Electric Features								Cable
	Working moment (*)		FC		Weight		Power		Current		Ia/In		Temp. Class	Glande	
	Kgcm		Kg		Kg		Kw		A max (Δ)						
	50Hz	60Hz	50Hz	60Hz	50Hz	60Hz	50 Hz	60 Hz	50Hz	60Hz	50Hz	60Hz	Dust		
												(°C)			
MVE 7200/15S	576.76	397.32	7246	7188	253.0	246.6	5.00	6.00	9.60	9.41	6.80	6.90	135	M32	
MVE 9000/15S	717.97	498.76	9020	9023	268.6	258	7.50	8.50	12.00	12.00	7.00	7.00	135	M32	
MVE 10000/15S	800.11	588.30	10052	10643	312	297	7.80	9.40	13.00	13.00	6.50	6.40	135	M32	

(*) = Working moment = 2 x static moment

FIG.	Size	Dimensional Features																	
		C		M		M1		A	B	Ø G	Holes	D	E	F	H	I	L	N	N1
		(mm)	(mm)	(mm)	(mm)	(mm)	(mm)	(mm)	(mm)	(mm)	n°	(mm)	(mm)	(mm)	(mm)	(mm)	(mm)	(mm)	(mm)
A	60	538		98		188	140	190	17	4	229	247	30	120	247	220	222	272	
A	60	538		98		188	140	190	17	4	229	247	30	120	247	220	222	272	
A	60	569	538	129	98	188	140	190	17	4	229	247	30	120	247	220	222	272	
A	75	677	652	140	115	229	155	255	23.5	4	302	318	35	147	295	273	264	315	
A	75	677		140		229	155	255	23.5	4	302	318	35	147	295	273	264	315	
A	80	695		130		222	180	280	26	4	332	360	37	167	345	304	310	361	

FIG.	Size	Dimensional Features																	
		C		M		M1		A	B	Ø G	Holes	D	E	F	H	I	L	N	N1
		(mm)	(mm)	(mm)	(mm)	(mm)	(mm)	(mm)	(mm)	(mm)	n°	(mm)	(mm)	(mm)	(mm)	(mm)	(mm)	(mm)	(mm)
A	85	723		120		238	200	320	28	4	385	410	49	200	422	325	378	430	
A	85	723		120		238	200	320	28	4	385	410	49	200	422	325	378	430	
B	90	804	764	160	120	238	125	380	38	6	452	430	44	204	422	367	378	430	

NOTE: Dimensions with coarse degree of accuracy related to UNI 22768/1

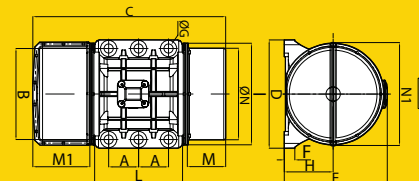
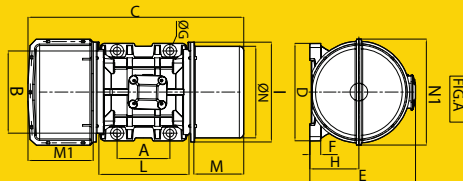
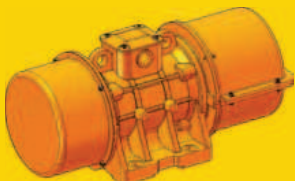

MVE-S with split covers

► 6 POLES

1000-1200 rpm

Ex IIBD T100°C resp T135°C – IP65
 TUV NORD Statement Conformity Number TUV 05 ATEX 2768X
 - Equipment and protective system intended for use in potentially explosive atmospheres (Zone 22) - Directive 94/9/EC
 - Compliance with Essential Health and Safety Requirements EN 61241-10



CE Declaration of conformity "type A" according to:
 - 73/23/EEC - 98/37/EEC - EN 60034-1

TYPE	Mechanical Features						Electric Features								Cable
	Working moment (*)		FC		Weight		Power		Current		Ia/In		Temp. Class	Glande	
	KgcM		Kg		Kg		Kw		A max (Y)						
	50Hz	60Hz	50Hz	60Hz	50Hz	60Hz	50 Hz	60 Hz	50 Hz	60 Hz	50Hz	60Hz	Dust		
MVE 800/1S	137.37	108.58	767	873	61.8	59.4	0.68	0.76	1.29	1.26	2.80	2.80	135	M25	
MVE 1100/1S	187.69	137.31	1048	1104	79.4	73.0	0.75	0.80	1.42	1.32	3.20	3.10	135	M25	
MVE 1500/1S	284.76	196.51	1590	1580	83.6	76.5	1.10	1.30	2.10	2.00	3.30	3.30	135	M25	
MVE 2600/1S	467.44	306.70	2610	2466	148.6	131.5	1.96	2.10	3.63	3.38	4.80	4.80	135	M32	
MVE 3000/1S	540.33	379.71	3017	3053	155.4	137.8	2.20	2.40	4.50	4.30	5.00	5.00	135	M32	
MVE 3800/1S	680.38	437.41	3799	3517	215.6	194.8	2.50	3.00	4.67	4.88	5.90	6.00	135	M32	
MVE 4700/1S	838.34	584.17	4681	4697	230.8	212.4	3.20	3.90	6.50	6.00	5.50	5.70	135	M32	
MVE 5200/1S	929.86	654.57	5192	5263	279.8	264.2	3.80	4.00	6.92	6.36	5.50	5.50	135	M32	
MVE 6500/1S	1165.19	823.96	6506	6625	304.4	280.7	4.30	5.00	7.76	7.81	6.20	6.00	135	M32	

TYPE	Mechanical Features						Electric Features								Cable
	Working moment (*)		FC		Weight		Power		Current		Ia/In		Temp. Class	Glande	
	KgcM		Kg		Kg		Kw		A max (Δ)						
	50Hz	60Hz	50Hz	60Hz	50Hz	60Hz	50 Hz	60 Hz	50 Hz	60 Hz	50Hz	60Hz	Dust		
MVE 8000/1S	1435.98	929.80	8018	7476	325	290	7.10	7.50	12.60	11.60	6.00	6.20	135	M32	
MVE 9000/1S	1600.39	1165.23	8936	9369	338	308	7.50	8.30	13.20	12.60	6.30	6.20	135	M32	
MVE 10000/1S	1788.44	1239.98	9986	9970	386	359	7.60	8.00	13.50	12.70	6.40	6.40	135	M32	

(*) = Working moment = 2 x static moment

FIG.	Size	Dimensional Features																
		C (mm)		M (mm)		M1 (mm)	A (mm)	B (mm)	Ø G (mm)	Holes (n°)	D (mm)	E (mm)	F (mm)	H (mm)	I (mm)	L (mm)	N (mm)	N1 (mm)
		50Hz	60Hz	50Hz	60Hz	50Hz - 60Hz	(mm)	(mm)	(mm)	n°	(mm)	(mm)	(mm)	(mm)	(mm)	(mm)	(mm)	(mm)
A	60	538		98		188	140	190	17	4	229	247	30	120	247	220	222	272
A	60	569	538	129	98	188	140	190	17	4	229	247	30	120	247	220	222	272
A	60	596	569	154	129	188	140	190	17	4	229	247	30	120	247	220	222	272
A	75	737	677	200	140	229	155	255	23.5	4	302	318	35	147	295	273	264	315
A	75	737	687	200	150	229	155	255	23.5	4	302	318	35	147	295	273	264	315
A	80	735	695	170	130	222	180	280	26	4	332	360	37	167	345	304	310	361
A	80	760	735	195	170	222	180	280	26	4	332	360	37	167	345	304	310	361
A	85	763	723	160	120	238	200	320	28	4	385	410	49	200	422	325	378	430
A	85	763		160		238	200	320	28	4	385	410	49	200	422	325	378	430

FIG.	Size	Dimensional Features																
		C (mm)		M (mm)		M1 (mm)	A (mm)	B (mm)	Ø G (mm)	Holes (n°)	D (mm)	E (mm)	F (mm)	H (mm)	I (mm)	L (mm)	N (mm)	N1 (mm)
		50Hz	60Hz	50Hz	60Hz	50Hz - 60Hz	(mm)	(mm)	(mm)	n°	(mm)	(mm)	(mm)	(mm)	(mm)	(mm)	(mm)	(mm)
A	85	813	763	210	160	238	200	320	28	4	385	410	49	200	422	325	378	430
A	85	813	763	210	160	238	200	320	28	4	385	410	49	200	422	325	378	430
B	90	854		210		238	125	380	38	6	452	430	44	204	422	367	378	430

NOTE: Dimensions with coarse degree of accuracy related to UNI 22768/1

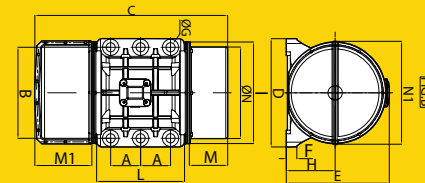
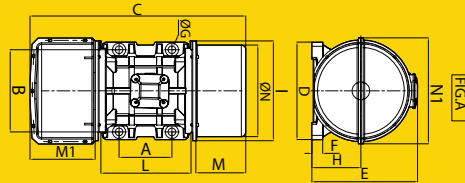
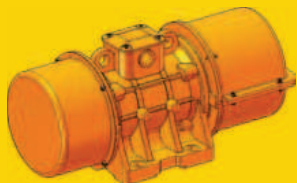

MVE-S with split covers
 ► 8 POLES
 850-900 rpm

Ex IIBD T100°C resp T135°C – IP65
 TÜV NORD Statement Conformity Number TUV 05 ATEX 2768X
 - Equipment and protective system intended for use in potentially explosive atmospheres (Zone 22) - Directive 94/9/EC
 - Compliance with Essential Health and Safety Requirements EN 61241-10



CE Declaration of conformity "type A" according to:
 - 73/23/EEC - 98/37/EEC - EN 60034-1

TYPE	Mechanical Features				Electric Features							
	Working moment (*) KgcM 50Hz - 60Hz	FC Kg 50Hz 60Hz		Weight Kg 50Hz - 60Hz	Power Kw 50 Hz 60 Hz		Current A max (Y) 50 Hz 60 Hz		Ia/In 50Hz 60Hz		Ex Temp. Class Dust (°C)	Cable Glande Class Temp
		400V	460V		400V	460V	400V	460V				
									400V	460V		
MVE 650/075S	137.31	431	621	64.7	0.50	0.60	1.20	1.20	2.20	2.20	135	M25
MVE 900/075S	187.72	589	849	71.0	0.65	0.78	1.23	1.29	2.50	2.50	135	M25
MVE 2100/075S	467.41	1468	2114	150.4	1.50	1.80	2.81	2.89	4.20	4.10	135	M32
MVE 3100/075S	680.34	2137	3077	212.2	2.00	2.30	3.79	3.77	4.00	4.00	135	M32
MVE 3800/075S	838.43	2633	3792	230.2	2.50	3.00	6.00	6.00	3.90	4.00	135	M32
MVE 4200/075S	929.74	2920	4205	284.5	2.90	3.40	6.50	6.50	3.80	3.70	135	M32
MVE 5300/075S	1165.22	3660	5270	305	4.00	4.30	8.50	8.00	3.80	4.20	135	M32
MVE 6500/075S	1435.85	4510	6494	324.4	5.00	5.90	10.00	10.00	3.60	4.00	135	M32

(*) = Working moment = 2 x static moment

TYPE	Dimensional Features																
	FIG.	Size	C	M	M1	A	B	Ø G	Holes	D	E	F	H	I	L	N	N1
			(mm) 50Hz - 60Hz	(mm) 50Hz - 60Hz	(mm) 50Hz - 60Hz	(mm)	(mm)	(mm)	n°	(mm)	(mm)	(mm)	(mm)	(mm)	(mm)	(mm)	(mm)
MVE 650/075S	A	60	538	98	188	140	190	17	4	229	247	30	120	247	220	222	272
MVE 900/075S	A	60	569	129	188	140	190	17	4	229	247	30	120	247	220	222	272
MVE 2100/075S	A	75	737	200	229	155	255	23.5	4	302	318	35	147	295	273	264	315
MVE 3100/075S	A	80	735	170	222	180	280	26	4	332	360	37	167	345	304	310	361
MVE 3800/075S	A	80	760	195	222	180	280	26	4	332	360	37	167	345	304	310	361
MVE 4200/075S	A	85	763	160	238	200	320	28	4	385	410	49	199	422	325	378	430
MVE 5300/075S	A	85	763	160	238	200	320	28	4	385	410	49	199	422	325	378	430
MVE 6500/075S	A	85	813	210	238	200	320	28	4	385	410	49	199	422	325	378	430

NOTE: Dimensions with coarse degree of accuracy related to UNI 22768/1

