



MOKA
wardrobe storage system

by emuca 

COMPOSITIONS

Composizioni . Composiciones . Compositions . Composições

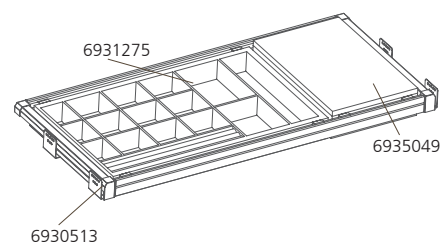
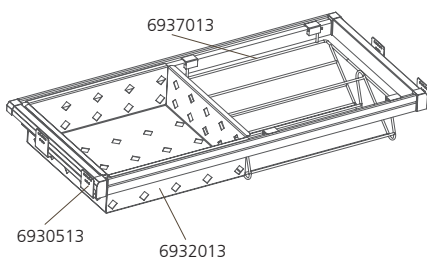
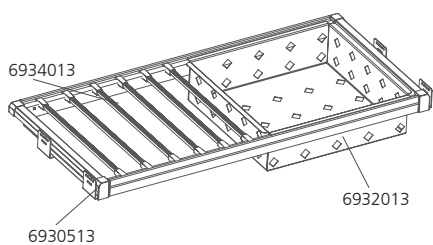
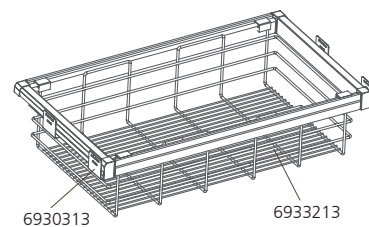
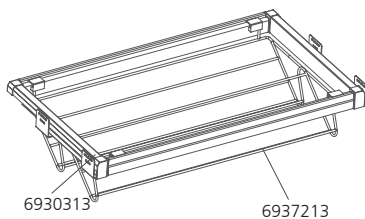
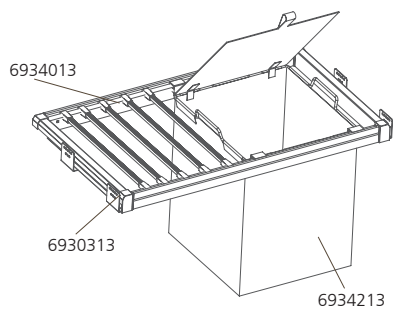
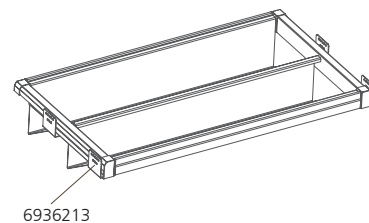
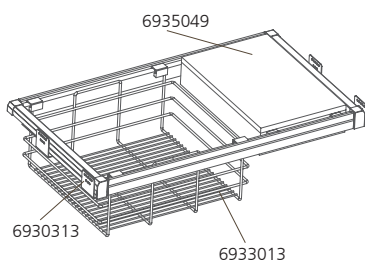
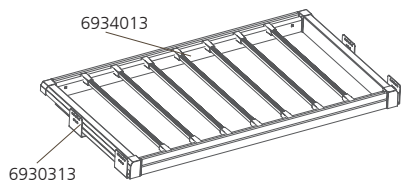
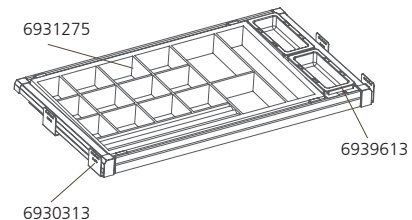
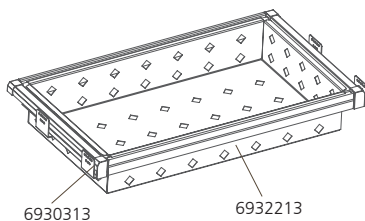
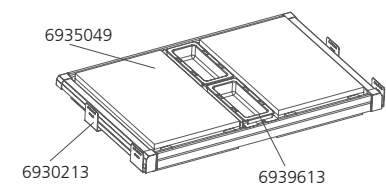

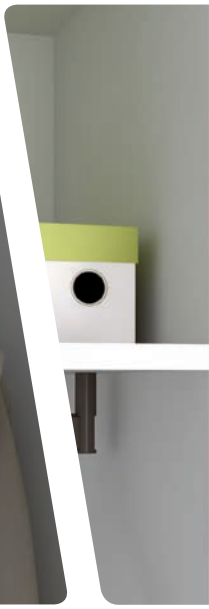

MOKA

wardrobe storage system

by emuca 

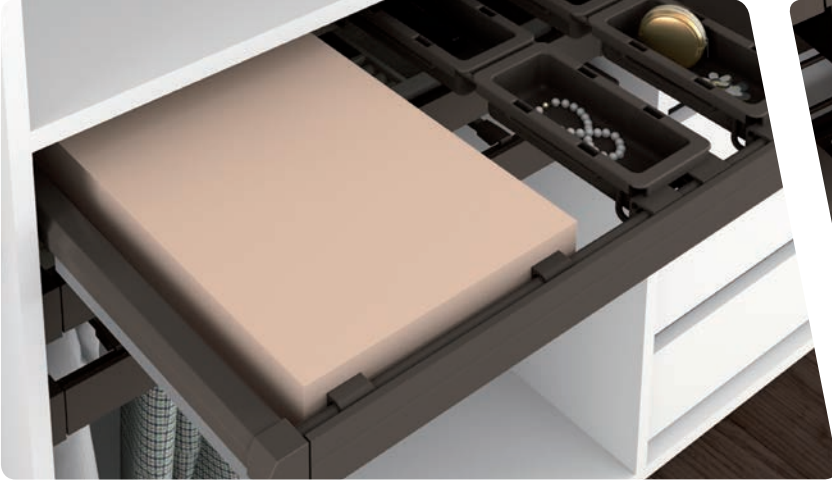

Pull-out hanging rail

Appendiabiti - Colgador abatibile
Penderie rabattabile - Varão basculante

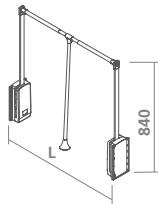

L	Cod.	
450 - 600	92837 13	1
600 - 830	92838 13	1
830 - 1.150	92839 13	1

ST / PL

Rails and supports

Tubi e reggitubi - Tubos y soportes - Tringles et supports - Varões e suportes



L	Cod.	
4 m	70141 13	40 m
2 m	70142 13	20 m

AL

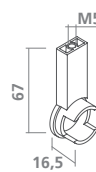

Cod.	
79192 13	200

ZM

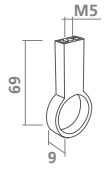

Cod.	
79197 13	200

ZM

MOKA FRAME WITH RUNNERS

Telaio Moka con guide - Bastidor con guías Moka - Cadre coulissant Moka - Bastidor Moka com corredeiras

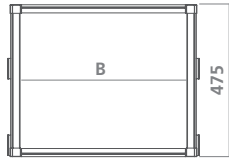
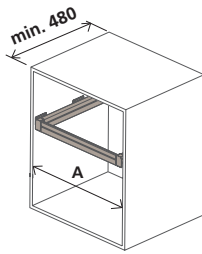

A	B	Cod.		
564 - 614	484 - 534	69300	13	1
614 - 664	534 - 584	69299	13	1
664 - 714	584 - 634	69301	13	1
714 - 764	634 - 684	69306	13	1
764 - 814	684 - 734	69302	13	1
814 - 864	734 - 784	69307	13	1
864 - 914	784 - 834	69303	13	1
914 - 964	834 - 884	69308	13	1
964 - 1.014	884 - 934	69304	13	1
1.014 - 1.064	934 - 984	69309	13	1
1.064 - 1.114	984 - 1.034	69305	13	1

AL / PL

Spacers

Distanziali - Distanciadores

Séparateurs - Distanciadores

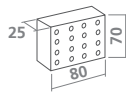

Cod.		
69399	43	1

PL

Pull-out trouser rack

Porta pantaloni estraibile - Pantalonerò estraibile

Porte-pantalons extractible - Porta calças extraível

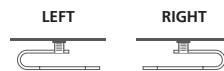
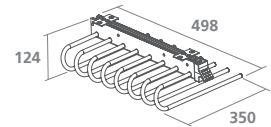

	Cod.		
LEFT	69128	13	1
RIGHT	69234	13	1

AL / PL



Runners included . Guide incluse . Incluye guías . Coulisses compris . Inclui corredeiras

RACK ACCESSORIES MOKA

Accessori per telaio Moka - Accesorios para el bastidor Moka - Accessoires pour cadre coulissant Moka - Acesoários para bastidor Moka

Metallic drawer

Cassetto metallico - Cajón metálico

Panier métallique - Gavetao metálico

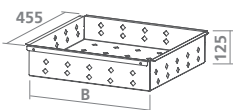

B	Cod.		
475	69320 13	1	
675	69321 13	1	
775	69322 13	1	

ST

Wire drawer

Cassetto in filo - Cajón de alambre

Panier en fil - Gaveta de arame

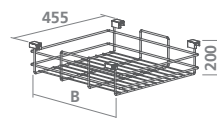

B	Cod.		
475	69330 13	2	
675	69331 13	2	
775	69332 13	2	

ST

Shoe drawer

Porta scarpe - Cajón zapatero

Rangement de chaussures - Cesto sapateira

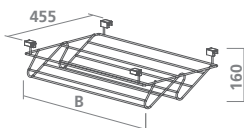
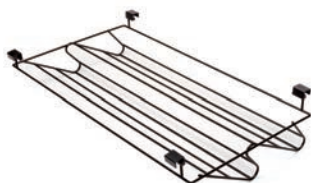

B	Cod.		
475	69370 13	2	
675	69371 13	2	
775	69372 13	2	

ST

Organizer drawer

Cassetto organizzatore - Cajón organizador

Tiroir organisateur - Gaveta organizadora

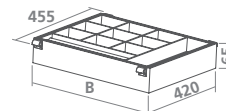

B	Cod.		
483	69310 75	1	
683	69311 75	1	
783	69312 75	1	

Wood

Basket

Cesta - Cesto - Panier - Cesto

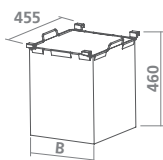

B	Cod.		
355	69342 13	1	

ST

Wooden tray with lid

Cassetto di legno - Cajón de madera

Tiroir en bois - Gaveta de madeira

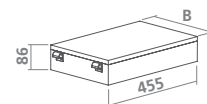

B	Cod.		
270	69350 49	1	

Wood

Auxiliary tray

Vaschetta ausiliare - Bandeja auxiliar

Plateaux auxiliaire - Travessa auxiliar

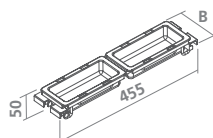

B	Cod.		
99	69396 13	1	

AL / PL

Set of 7 trousers rods

Set di 7 aste porta pantaloni - Juego de 7 varillas pantalonero

Jeu 7 tringles porte-pantalons - Jogo de 7 varetas porta calças



Cod.			
69340 13	1		

AL / PL

AL, ST, PL, ZM, WOOD:

Aluminium, Steel, Plastic, Zamak, Wood • Alluminio, Acciaio, Tecnoplastica, Zama, Legno • Aluminio, Acero, Plástico, Zamak, Madera • Aluminium, Acier, Plastique, Zamak, Bois
Alumínio, Aço, Plástico, Zamak, Madeira

MOKA ACCESSORIES

Accessori Moka - Accesorios Moka - Accessoires Moka - Acessórios Moka

Shoe rack with frame*

Portascarpe con telaio - Zapatero con bastidor

Porte-chaussures avec cadre coulissant - Sapateira com bastidor

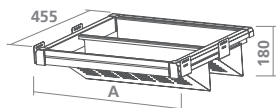

A	Cod.		
564 - 594	69360 13	1	
764 - 794	69361 13	1	
864 - 894	69362 13	1	

*Frame included . Telaio include
Incluye bastidor . Cadre compris
Inclui bastidor

ST

Lateral pull-out shoe rack

Porta scarpe laterale estraibile - Zapatero lateral extraíble

Rangement de chaussures latéral extractible - Sapateira lateral extraível

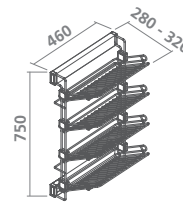

LEFT



RIGHT



	Cod.		
LEFT	69384 13	1	
RIGHT	69385 13	1	

ST

Pull-out hanging rail

Appendiabiti estraibile - Colgador extraíble

Porte-vêtements extractible - Cabide extraível

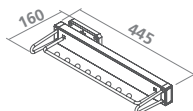

Cod.			
69387 13	1		

AL / PL

Lateral pull-out tie rack*

Porta cravatte laterale estraibile - Corbatero lateral extraíble

Porta cravatas latéral extractible - Porta gravatas lateral extraível

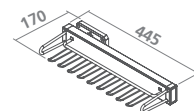

Cod.			
69388 13	1		

AL / PL

* Fastening on both sides . Fissaggio su ambo i lati
Fijación a ambos lados . Fixation sur les deux côtés
Fixação a ambos lados

Pull-out mirror

Specchio estraibile - Espejo extraíble

Miroir extractible - Espelho extraível

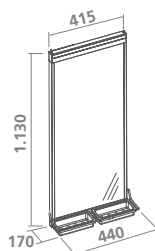

Cod.			
69386 13	1		

AL / PL



13 Moka painted . Verniciato moka . Pintado moka . Peint couleur moka . Pintado moka

43 Moka plastic . Plastica moka . Plástico moka . Plastique moka . Plástico moka

49 Sand painted . Verniciato sabbia . Pintado arena . Peint couleur sable . Pintado areia

75 Walnut wood . Legno noce . Madera nogal . Bois de noyer . Madeira nogueira

emuca 

emuca.com

emuca.it • emuca.co.uk • emuca.es • emuca.fr • emuca.pt

Emuca S.R.L.

Via Messico, 80 • 35127 Padova (ITALIA)
T. +39 049 8702800 • F. +39 049 8703019
www.emuca.it • info@emuca.com

Emuca Ltd.

75 Springfield Road • Chelmsford • Essex
CM2 6JB (UK)
T. +44 1268 530 674 • F. +44 1268 282 592
www.emuca.co.uk • sales@emuca.com

Emuca S.A.

Pl. El Oliveral - c/H, 4 • Apartado de correos 176
46394 Riba-Roja del Túria • Valencia (ESPAÑA)
T. +34 96 166 70 19 • F. +34 96 166 71 82
www.emuca.es • emuca@emuca.com

Emuca S.A.R.L.

Parc de l'Aubinière • 2 Av. des Améthystes
44338 Nantes Cedex 03 (FRANCE)
T. +33 2 49 88 07 35 • F. +33 2 72 22 02 24
www.emuca.fr • emuca@emuca.com

Emuca Lda.

AV. da Liberdade nº 36, 6º • 01250 Lisboa (PORTUGAL)
T. +351 211 203 940 • F. +34 96 166 71 82
www.emuca.pt • emuca@emuca.com



05/2017 Cod. 900285

