



ACVATIX™

Electromotoric actuators for valves

SAX..

with a 20 mm stroke

-
- **SAX31..** Operating voltage AC 230 V, 3-position control signal
 - **SAX61..** Operating voltage AC/DC 24 V, control signal DC 0...10 V, 4...20 mA
 - **SAX81..** Operating voltage AC/DC 24 V, 3-position control signal
 - **SAX61..** Position feedback, override control, choice of flow characteristic
 - For direct mounting on valves; no adjustments required
 - Manual adjuster, position indicator and status indication per LED
 - Optional functions with auxiliary switches, potentiometer, function module, stem heating element

Use

For the operation of Siemens 2-port and 3-port valves, types V..F21.., V..F22.., V..F31.., V..F32.., V..F40.., V..F41.., V..G41.., V..F42.., VVF52.. and V..F53.. with 20 mm stroke as control and safety shut-off valves in heating, ventilation and air conditioning systems.

Type summary

Product no.	Stock no.	Stroke	Pos. force	Operating voltage	Positioning signal	Spr. ret. time	Pos. time	LED	Manual adjuster	Extra functions	
SAX31.00	S55150-A105	20 mm	800 N	AC 230 V	3-Punkt	-	120 s	-	Push and fix	-	
SAX31.03	S55150-A106			AC/DC 24 V	DC 0...10 V DC 4...20 mA 0...1000 Ω		3-Punkt	30 s		✓	Position feedback, forced control, change of characteristic
SAX61.03 SAX61.03U	S55150-A100 S55150-A100-A100									-	-
SAX81.00 SAX81.00U	S55150-A102 S55150-A102-A100			120 s	-		-				
SAX81.03 SAX81.03U	S55150-A103 S55150-A103-A100			30 s	-		-				

Electrical accessories

Product no.	Auxiliary switch ASC10.51	Potentiometer ASZ7.5/.. ¹⁾	Function module AZX61.1	Stem heating element ASZ6.6
Stock no.	S55845-Z103	S55845-Z104 (ASZ7.5/135) S55845-Z105 (ASZ7.5/200) S55845-Z106 (ASZ7.5/1000)	S55845-Z107	S55845-Z108
	Max. 2			Max. 1
SAX31..	Max. 2	Max. 1	-	Max. 1
SAX61..	Max. 2	-	Max. 1 AZX61.1	
SAX81..		Max. 1	-	

¹⁾ Available with 135 Ω, 200 Ω or 1000 Ω

Mechanical Accessory

Weather shield ASK39.1

Ordering



Example

Product no.	Stock no.	Description	Quantity
SAX81.03	S55150-A103	Actuator	1
ASZ7.5/1000	S55845-Z106	Potentiometer	1

Delivery

Actuators, valves and accessories are supplied in individual packs.

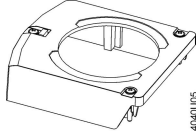
Spare parts

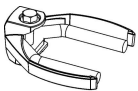
Product number / Stock number	Description	Image
8000060843	Housing cover	
	Screw (valve stem coupling)	
	U-bracket	

Product documentation

Detailed Informations about the New Generation actuators can be found in the Basic documentation "Electromotoric actuators SAX.." (CE1P4040_01en).

Combinations

Type reference		DN	PN class	K_{vs} [m ³ /h]	Data sheet
2-port valves VV.. (control or safety shutoff valves)					
VVF21..	flange	25...80	6	1.9...100	N4310
VVF22..	flange	25...80	6	2.5...100	N4401
VVF31..	flange	15...80	10	2.5...100	N4320
VVF32..	flange	15...80	10	1.6...100	N4402
VVF40..	flange	15...80	16	1.9...100	N4330
VVF41..	flange	50		19 / 31	N4340
VVF42..	flange	15...80		1.6...100	N4403
VVF42..K	flange	50...80		40...100	
VVG41..	thread	15...50		0.63...40	N4363
VVF52..	flange	15...40	25	0.16...25	N4373
VVF53..	flange	15...50		0.16...40	N4405
3-port valves VX.. (control valves for "mixing" and "diverting" functions)					
VXF21..	flange	25...80	6	1.9...100	N4410
VXF22..	flange	25...80	6	2.5...100	N4401
VXF31..	flange	15...80	10	2.5...100	N4420
VXF32..	flange	15...80	10	1.6...100	N4402
VXF40..	flange	15...80	16	1.9...100	N4430
VXF41..	flange	15...50		1.9...31	N4440
VXF42..	flange	15...80		1.6...100	N4403
VXG41..	thread	15...50		1.6...40	N4463
VXF53..	flange	15...50	25	1.6...40	N4405

Notes

Engineering
SAX31.. and SAX81..

3-position actuators must have their own specific controller, refer to "Connection Diagrams" (page 7).

SAX61..

Up to 10 actuators can drive in parallel on a controller output with a rating of 1 mA. Modulating actuators have an input impedance of 100 kΩ.

Mounting

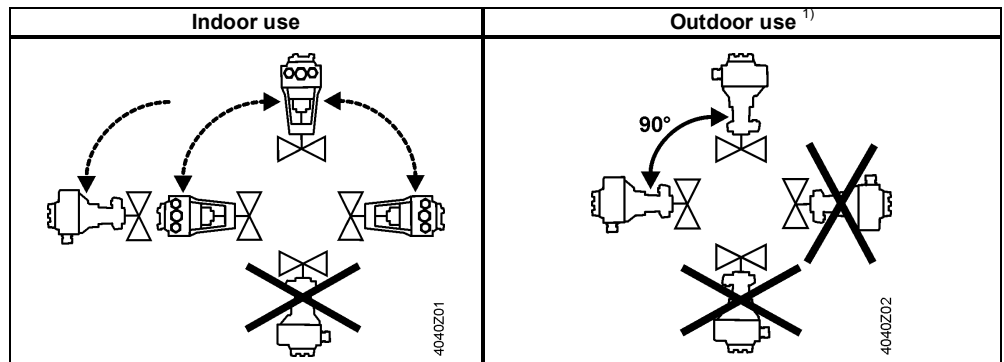

¹⁾ Only in connection with weather shield ASK39.1

Maintenance

The actuators are maintenance-free.

Warranty

The engineering data specified in chapter "Combinations" (page 3) are only guaranteed in connection with the Siemens valves listed.

Note

When using the actuators in connection with valves of other manufacture, correct functioning must be ensured by the user, and Siemens will assume no responsibility.

Technical Data

		SAX..
Power supply	Operating voltage SAX31.. SAX61.. SAX81..	AC 230 V ±15% AC 24 V ± 20% / DC 24 V + 20% / -15% (SELV) AC 24 V ±20% / DC 24 V + 20 % / -15% (SELV)
	Frequency	45...65Hz
	External supply line protection (EU)	<ul style="list-style-type: none"> Fuse slow 6...10 A Circuit breaker max. 13 A, Characteristic B, C, D according to EN 60898 Power source with current limitation of max. 10 A
	Power consumption at 50 Hz SAX31.00 Stem retracts / extends SAX31.03 Stem retracts / extends SAX61.03.. Stem retracts / extends SAX81.00.. Stem retracts / extends SAX81.03.. Stem retracts / extends	3.5 VA / 2 W 6 VA / 3.5 W 8 VA / 3.75 W 3.5 VA / 2.25 W 5 VA / 3.75 W
Function data	Positioning times (with the specified nominal stroke) The positioning time can vary, depending on the type of valve -> refer chapter "Type summary" (page 2) SAX31.00, SAX81.00.. SAX31.03, SAX61.03.., SAX81.03.. Positioning force Nominal stroke Working stroke area the actuator is able to calibrate Permissible medium temperature (valve fitted)	120 s 30 s 800 N 20 mm 6 .. 24 mm -25°...130 °C
Signal inputs	Positioning signal "Y" SAX31.., SAX81.. SAX31.. Voltage SAX81.. Voltage SAX61.. (DC 0...10 V) Current draw Input impedance SAX61.. (DC 4...20 mA) Current draw Input impedance	3-position AC 230 V ±15% AC 24 V ± 20 % / DC 24 V + 20 % / -15% ≤ 0.1 mA ≥100 kΩ DC 4...20 mA ± 1% ≤500 Ω
Parallel operation	SAX61..	≤ 10 (depending on controller output)
Forced control	Positioning signal "Z" SAX61.. R = 0...1000 Ω Z connected to G Z connected to G0 Voltage Current draw	R = 0...1000 Ω, G, G0 Stroke proportional to R Max. stroke 100% ¹⁾ Min. stroke 0% ¹⁾ Max. AC 24 V ± 20% Max. DC 24 V + 20% / -15% ≤ 0.1 mA
Position feedback	Position feedback U SAX61.. Load impedance Load	DC 0...10 V ± 1% >10 kΩ res. Max. 1 mA
Connecting cable	Wire cross-sectional areas Cable entries SAX.. SAX..U	0.13...1.5 mm ² , AWG 24...16 ²⁾ EU: 2 entries Ø 20.5 mm (for M20) 1 entry Ø 25.5 mm (for M25) US: 3 entries Ø 21.5 mm for ½" tube connection
Degree of protection	Housing from vertical to horizontal Insulation class Actuators SAX31.. AC 230 V Actuators SAX61.. AC / DC 24 V Actuators SAX81.. AC / DC 24 V	IP54 as per EN 60529 ³⁾ As per EN 60730 II III III
Environmental conditions	Operation Climatic conditions Mounting location Temperature General Humidity (noncondensing)	IEC 60721-3-3 Class 3K5 Indoors (weather-protected) -5...55 °C 5...95% r.h.
	Transport Climatic conditions Temperature Humidity	IEC 60721-3-2 Class 2K3 -25...70 °C <95% r.h.
	Storage Climatic conditions Temperature Humidity	IEC 60721-3-1 Class 1K3 -15...55 °C 5...95% r.h.
	Max. media temperature when mounted on valve	130 °C

¹⁾ Observe acting direction of DIL switches

²⁾ AWG = American wire gauge

³⁾ Also with weather shield ASK39.1

Directives and Standards	Product standard Electromagnetic compatibility (Application)	EN 60730-x For residential, commercial and industrial environments CE1T4501X2 / CE1T4501X1 ¹⁾ CE1T4515X4 ¹⁾
	EU Conformity (CE) RCM Conformity	AC 230 V
	EAC Conformity	Eurasia Conformity for all SAX..
	UL, cUL	AC 230 V AC/DC 24 V - UL 873 http://ul.com/database
Environmental compatibility		The product environmental declaration 7173310559Ben ¹⁾ contains data on environmentally compatible product design and assessments (RoHS compliance, materials composition, packaging, environmental benefit, disposal).
Dimensions		See "Dimensions" (page 8)
Accessories ²⁾	Potentiometer ASZ7.5/135	0...135 Ω ± 5% DC 10 V Current rating <4 mA
	Potentiometer ASZ7.5/200	0...200 Ω ± 5% DC 10 V Current rating <4 mA
	Potentiometer ASZ7.5/1000	0...1000 Ω ± 5% DC 10 V Current rating <4 mA
	Auxiliary switch ASC10.51 External supply line protection US Installation, UL & cUL	Switching capacity AC 24...230 V, 6 (2) A, floating See section power supply AC 24 V class 2, 5 A general purpose
	Stem heating element ASZ6.6	Power supply AC/DV 24 V, ± 20% Power consumption 40 VA / 30 W Inrush current (cold) 13 A

¹⁾ The documents can be downloaded from <http://siemens.com/bt/download>.

²⁾ UL recognized component



Connection Diagrams

Internal Diagrams

SAX31..

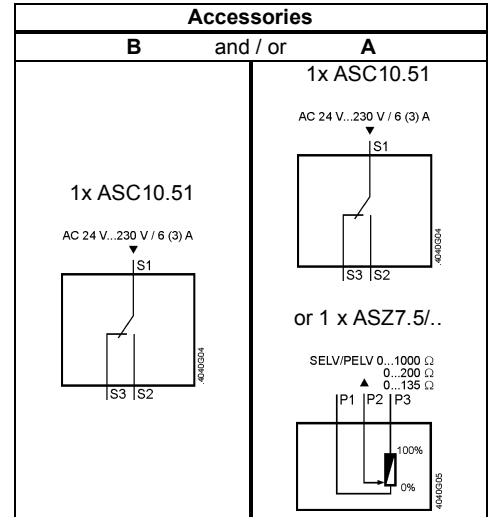
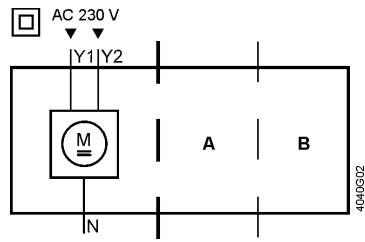

SAX61..

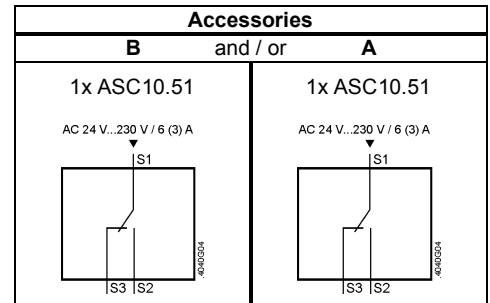
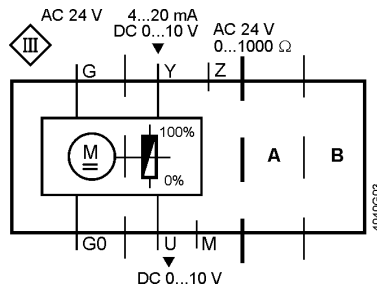

SAX81..

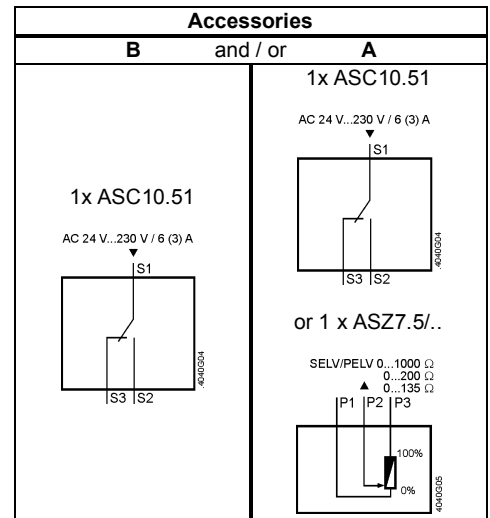
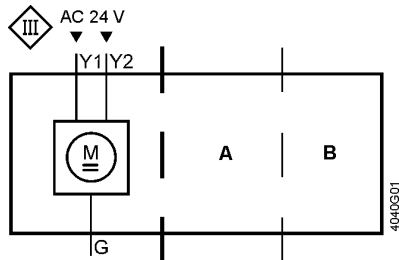

Connection terminals

SAX31..

AC 230 V, 3-position

- N** — System neutral (SN)
- Y1** — Positioning signal (actuator's stem extends)
- Y2** — Positioning signal (actuator's stem retracts)

SAX61..

AC/DC 24 V, DC 0...10 V / 4...20 mA / 0...1000 Ω

- G0** Sytem neutral (SN)
- G** Sytem potential (SP)
- Y** Positioning signal for DC 0...10 V / 4...20 mA
- M** Measuring neutral
- U** Position feedback DC 0...10 V - (reference potential is M measuring neutral)
- Z** Positioning signal forced control

SAX81..

AC/DC 24 V, 3-position

- G** Sytem potential (SP)
- Y1** Positioning signal (actuator's stem extends)
- Y2** Positioning signal (actuator's stem retracts)

Connection Diagrams
SAX31..

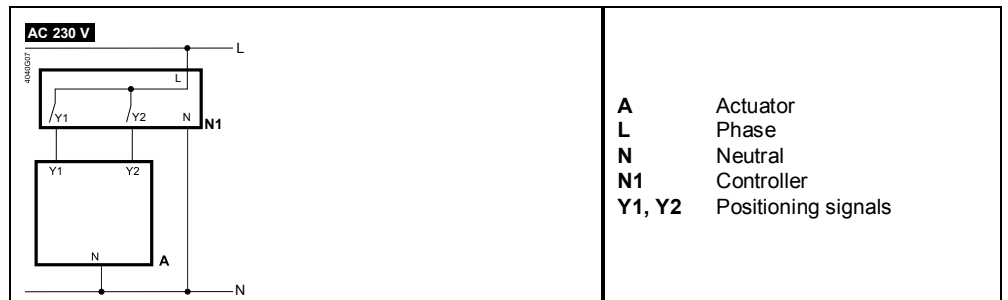

SAX61..

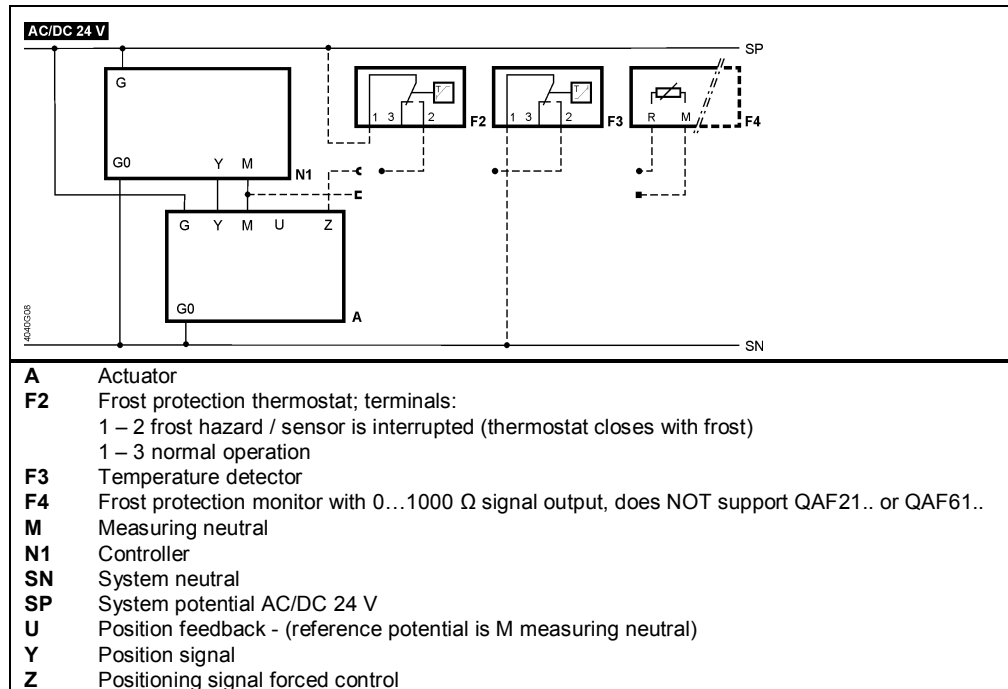

SAX81..

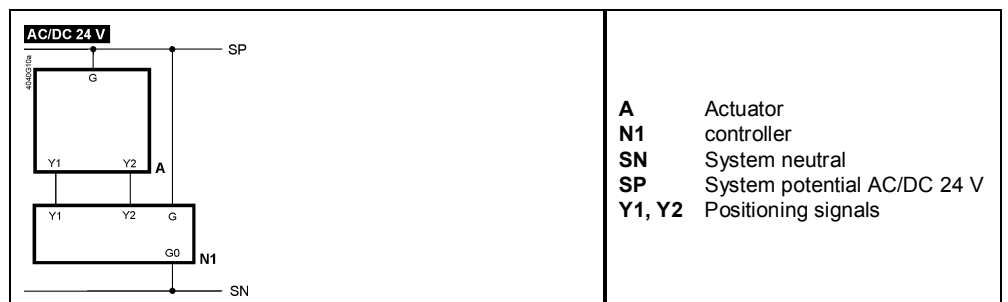

Dimensions

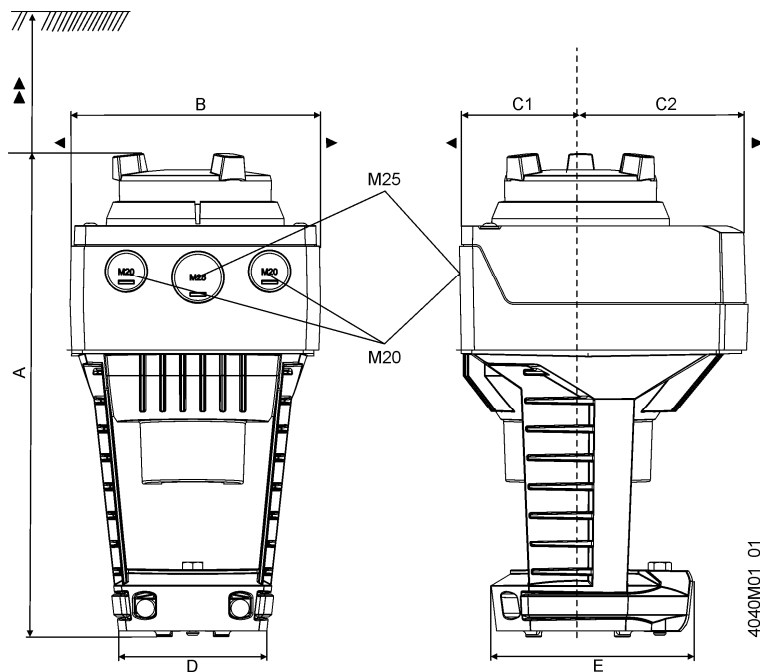

Product no.	A	B	C	C1	C2	D	E	▶	▶▶	kg
SAX..(U ¹⁾)	242	124	150	68	82	80	100	100	200	1.780
With ASK39.1	+25	154	300	200	100	-	-	-	-	2.010

Dimensions in mm

¹⁾SAX..U: For 1/2" tube connections (21.5 mm dia.); 1,850 kg

Revision numbers

Product no.	Valid from rev. no.
SAX31.00	..H
SAX31.03	..H
SAX61.03..	..H
SAX81.00..	..H
SAX81.03..	..H

Issued by
Siemens Switzerland Ltd
Building Technologies Division
International Headquarters
Gubelstrasse 22
6301 Zug
Switzerland
Tel. +41 41-724 24 24
www.siemens.com/buildingtechnologies

© Siemens Switzerland Ltd, 2011
Technical specifications and availability subject to change without notice.