

# Ø 22/25 mm I/O Push Button Switches



## S2TR Series CATALOG

For your safety, read and follow the considerations written in the instruction manual, other manuals and Autonics website.

The specifications, dimensions, etc. are subject to change without notice for product improvement. Some Models may be discontinued without notice.

### Features

- Smooth operation
- High electrical conductivity
- Long-lasting durability

### Safety Considerations

- Observe all 'Safety Considerations' for safe and proper operation to avoid hazards.
- ⚠ symbol indicates caution due to special circumstances in which hazards may occur.





**⚠ Warning** Failure to follow instructions may result in serious injury or death.





- 01. Fail-safe device must be installed when using the unit with machinery that may cause serious injury or substantial economic loss. (e.g. nuclear power control, medical equipment, ships, vehicles, railways, aircraft, combustion apparatus, safety equipment, crime / disaster prevention devices, etc.)**  
Failure to follow this instruction may result in personal injury, economic loss or fire.
- 02. Do not use the unit in the place where flammable / explosive / corrosive gas, high humidity, direct sunlight, radiant heat, vibration, impact, or salinity may be present.**  
Failure to follow this instruction may result in explosion or fire.
- 03. Install on a device panel to use.**  
Failure to follow this instruction may result in fire or electric shock.
- 04. Do not connect, repair, or inspect the unit while connected to a power source.**  
Failure to follow this instruction may result in fire or electric shock.
- 05. Do not disassemble or modify the unit.**  
Failure to follow this instruction may result in fire or electric shock.



**⚠ Caution** Failure to follow instructions may result in injury or product damage.

- 01. This unit shall not be used outdoors.**  
Failure to follow this instruction may result in shortening the life cycle of the product or electric shock.
- 02. Use the unit within the rated specifications.**  
Failure to follow this instruction may result in fire or product damage.
- 03. Do not use the load beyond rated switching capacity contact.**  
Failure to follow this instruction may result in fire, relay broken, contact melt, insulation failure or contact failure.
- 04. For wiring the product, do not pull the wiring excessively or apply excessive force.**  
Failure to follow this instruction may result in product damage or malfunction.
- 05. Use dry cloth to clean the unit, and do not use water or organic solvent.**  
Failure to follow this instruction may result in fire or electric shock.
- 06. Keep the product away from metal chip, dust, and wire residue which from flowing into the unit.**  
Failure to follow this instruction may result in fire or product damage.

## Specifications

<b>Series</b>	<b>S2TR Series</b>
<b>Actuation distance</b>	5.0 to 5.5 mm
<b>Actuation force</b>	0.5 kgf (4.9 N) (per 1 contact)
<b>Installation</b>	Extended
<b>Shock</b>	300 m/s <sup>2</sup> (≈ 30 G) in each X, Y, Z direction for 3 times
<b>Shock (malfunction)</b>	100 m/s <sup>2</sup> (≈ 10 G) in each X, Y, Z direction for 3 times
<b>Vibration</b>	1.5 mm amplitude at frequency of 10 to 55 Hz (for 1 min) in each X, Y, Z direction for 2 hours
<b>Vibration (malfunction)</b>	1.5 mm amplitude at frequency of 10 to 55Hz (for 1 min) in each X, Y, Z direction for 10 minutes
<b>Mechanical life cycle (control unit life cycle)</b>	≥ 1 million operations (20 operations/min)
<b>Ambient temperature</b>	-15 to 55 °C, storage : -25 to 65 °C (no freezing or condensation)
<b>Ambient humidity</b>	35 to 85 %RH, storage : 35 to 85 %RH (no freezing or condensation)
<b>Protection structure</b>	Control unit: IP50 (IEC standard)
<b>Approval</b>	CE     
<b>Control unit weight</b>	≈ 14.5 g
<b>Housing weight</b>	≈ 7 g

<b>Contact blocks</b>	
Power supply / current	110 VAC~ / 10 A, 250 VAC~ / 6 A
Dielectric strength	2,500 VAC~ 50/60 Hz for 1 minute
Insulation resistance	≥ 1,000 MΩ (500 VDC== megger)
Contact resistance	≤ 20 mΩ (initial)
Electrical life cycle	≥ 100,000 operations (20 operations/min)
Contact material	AgNi10
Approval	CE    
Weight	Modular type: ≈ 10 g, Singular type: ≈ 11 g

<b>LED blocks</b>	
Rated voltage	AC/DC voltage type: 12-24 VAC~ 50/60 Hz, 12-24 VDC== AC voltage type: 110-220 VAC~ 50/60 Hz
Current consumption	≤ 20 mA
Approval	CE   
Weight	AC/DC voltage type: ≈ 11 g, AC voltage type: ≈ 12 g

## Sold Separately

- Contact blocks (SA□-C□□)
- LED blocks (SA□-L□□□)
- Switch enclosures (SA-□B□)
- Locking handle (SA□-LH)
- Switch washer (SA-SW□)

## Assembly / Disassembly

- Assembly order: ①→②→③→④
- Disassembly order: ④→③→②→①

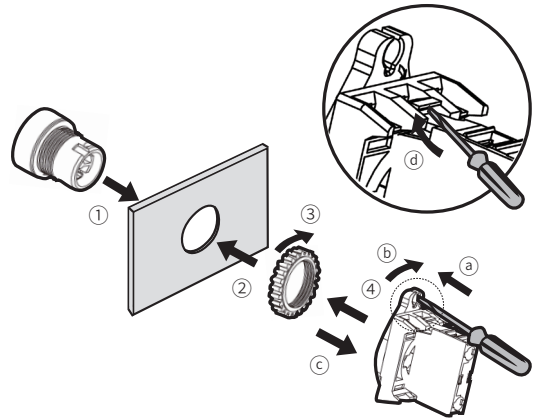

Control Switches	Panel thickness	Tightening torque
Ø 22/25/30 mm	Max. 6 mm	≤ 1.47 N·m

## Ordering Information

This is only for reference. For selecting the specified Model, follow the Autonics website.

Model is based on control unit+block combination. Control units or blocks are sold separately. In case of block, refer to control switch accessories.

### ■ Non-illuminated

<b>S2TR</b>	-	<b>P</b>	<b>1</b>	<b>W</b>	<b>①</b>	<b>②</b>
Control unit					Block	

#### ① Contact block

2A: 2 A contacts  
2B: 2 B contacts  
AB: 1 A contact, 1 B contact

#### ② Block

No mark: Singular type  
M: Modular type

Model	Contact block		LED block	
	A contact	B contact	AC/DC voltage	AC voltage
S2TR-P1W2A(M)	2	-	-	-
S2TR-P1W2B(M)	-	2		
S2TR-P1WAB(M)	1	1		

### ■ Illuminated

<b>S2TR</b>	-	<b>P</b>	<b>3</b>	<b>W</b>	<b>①</b>	<b>②</b>	<b>③</b>
Control unit					Block		

#### ① Contact block

2A: 2 A contacts  
2B: 2 B contacts  
AB: 1 A contact, 1 B contact

#### ③ Block

No mark: Singular type  
M: Modular type

#### ② LED block

D: 1 AC/DC voltage type  
L: 1 AC voltage type

Model	Contact block		LED block	
	A contact	B contact	AC/DC voltage	AC voltage
S2TR-P3W2AD(M)	2	-	1	-
S2TR-P3W2AL(M)	2	-	-	1
S2TR-P3W2BD(M)	-	2	1	-
S2TR-P3W2BL(M)	-	2	-	1
S2TR-P3WABD(M)	1	1	1	-
S2TR-P3WABL(M)	1	1	-	1

## Dimensions

- Unit: mm, For the detailed drawings, follow the Autonics website.
- Panel thickness: ≤ 6 mm

### ■ S2TR-□ (singular type block)

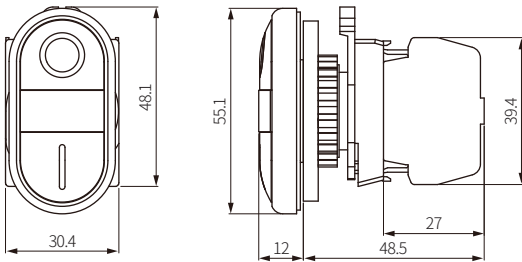

### ■ S2TR-□ M (modular type block)

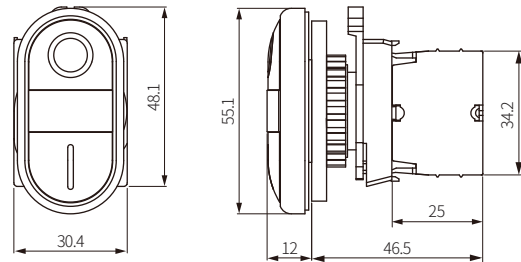

### ■ Panel cut-out

<Mounting round: Ø 25>

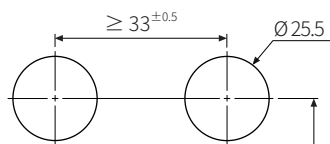

<Mounting round: Ø 22>

