

2-CH USB Temperature Data Logger

■ Features

- Multi-channel (4 channel/ 2 channel) simultaneous controlling possible
- Transmit 2-channels of real-time temperature data to PCs
- Record and monitor temperature using DAQ Master (comprehensive device management software)
- USB-powered device with USB communication interface (Modbus RTU)
- Supports various types of input (thermocouple, RTD, mA, V) and different sensors can be assigned to each channel.
- Easy wiring with plug/socket type terminal
- Compact, space-saving design
- DIN rail or screw mount

 Please read "Safety Considerations" in the instruction manual before using.



■ Comprehensive Device Management Program (DAQMaster)

- DAQMaster is comprehensive device management program for convenient management of parameters and multiple device data monitoring.
- Visit our website (www.autonics.com) to download user manual and comprehensive device management program.

< Computer specification for using software >

Item	Minimum requirements
System	IBM PC compatible computer with Intel Pentium III or above
Operations	Microsoft Windows 98/NT/XP/Vista/7/8/10
Memory	256MB+
Hard disk	1GB+ of available hard disk space
VGA	Resolution: 1024×768 or higher
Others	RS-232 serial port (9-pin), USB port

< DAQMaster screen >

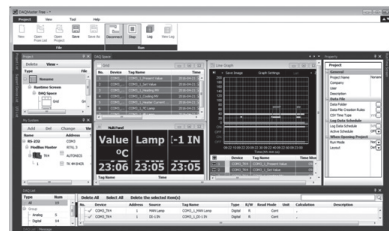

SENSORS
FIELD INSTRUMENTS
CONTROLLERS
MOTION DEVICES
SOFTWARE

(A) Temperature Controllers
(B) SSRs
(C) Power Controllers
(D) Counters
(E) Timers
(F) Digital Panel Meters
(G) Indicators
(H) Converters
(I) Digital Display Units
(J) Sensor Controllers
(K) Switching Mode Power Supplies
(L) Recorders
(M) HMIs
(N) Industrial PC
(O) Field Network Devices

SCM-USU2I

Specifications

Model		SCM-USU2I
Power supply		USB BUS POWER (5VDC \approx)
Permissible voltage range		90 to 110% of rated voltage
Communication method		USB
Protocol		Modbus RTU
Display method		Check via PC Software (DAQMaster)
Input type	RTD	DPT100 Ω , DPT50 Ω , JPT100 Ω , Cu100 Ω , Cu50 Ω , Nickel120 Ω
	Thermocouple	K(CA), J(IC), E(CR), T(CC), B(PR), R(PR), S(PR), N(NN), C(TT), G(TT), L(IC), U(CC), Platinel II
	Analog	Voltage: -60-60mV, 0-200mV, 0-1V, 1-5V, 0-5V, 0-10V Current: 0-20mA, 4-20mA
Display accuracy $\times 1$	RTD	●At room temperature range (23°C \pm 5°C) : (PV \pm 0.3% or \pm 1°C, select the higher one) \pm 1-digit
	Thermocouple	●Out of room temperature range : (PV \pm 0.5% or \pm 2°C, select the higher one) \pm 1-digit
	Analog	●At room temperature range (23°C \pm 5°C): \pm 0.3% F.S. \pm 1-digit ●Out of room temperature range: \pm 0.5% F.S. \pm 1-digit
Sampling period		50ms (2-CH simultaneous sampling)
Dielectric strength		500VAC 50/60Hz for 1 min (between input terminal and power terminal)
Vibration		0.75mm amplitude at frequency of 5 to 55Hz (for 1 min) in each X, Y, Z direction for 2 hours
Shock		500m/s ² (approx. 50G) in each X, Y, Z direction for 3 times
Insulation resistance		Over 100M Ω (at 500VDC megger)
Memory retention		Approx. 10 years (when using non-volatile semiconductor memory type)
Environment	Ambient temperature	-10 to 50°C, storage: -20 to 60°C
	Ambient humidity	35 to 85%RH, storage: 35 to 85%RH
Protection structure		IP20 (IEC standard)
Insulation type		Double insulation or reinforced insulation
Installation		DIN rail or panel mounting
Accessory		USB 2.0 AB type cable: 1 (length: 1m)
Approval		CE 
Weight $\times 2$		Approx. 195g (approx. 140g)

$\times 1$: ○ At room temperature range (23°C \pm 5°C)

- Below -100°C of thermocouple K, J, T, N, E, and L, U, PLII, RTD Cu50 Ω , DPT50 Ω
: (PV \pm 0.3% or \pm 2°C, select the higher one) \pm 1-digit
- Below 200°C of thermocouple C, G and R, S
: (PV \pm 0.3% or \pm 3°C, select the higher one) \pm 1-digit
- Below 400°C of thermocouple B does not have accuracy standard.

○ Out of room temperature range

- RTD Cu50 Ω , DPT50 Ω : (PV 0.5% or \pm 3°C, select the higher one) \pm 1-digit
- Thermocouple R, S, B, C, G, L, U: (PV \pm 0.5% or \pm 5°C, select the higher one) \pm 1-digit
- Below -100°C of other sensors: within \pm 5°C

$\times 2$: The weight includes packaging. The weight in parenthesis is for unit only.

\times Environment resistance is rated at no freezing or condensation.

Connections and Block Diagram

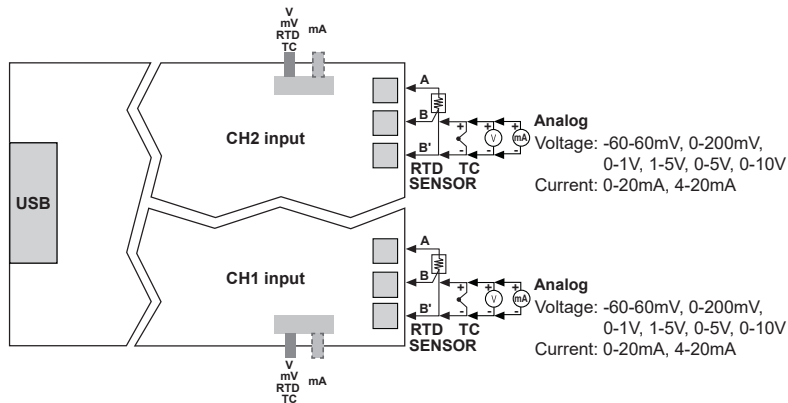

\times Input parts and USB cable connection part are insulated each other.

\times Use crimp terminals of size specified below.

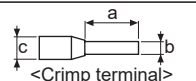
 <Crimp terminal>	Terminal number	a	b	c
	1 to N	6 to 8mm	Max. 1.5mm	Max. 3.5mm

2-CH USB Temperature Data Logger

■ Dimensions

(unit: mm)

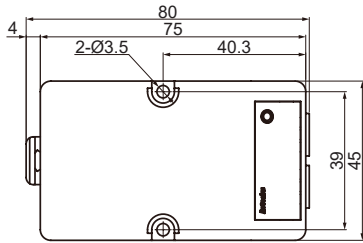

◎ Mounting hole

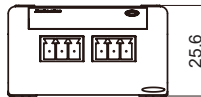
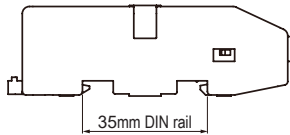
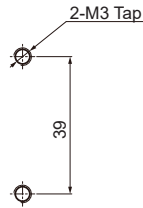

■ Installation

◎ Mounting & Removing the unit on DIN rail

● Mounting

- 1) Hook DIN rail connector on to DIN rail.
- 2) Push the unit down to the direction "①".

● Removing

- 1) Pull the rail lock of the unit to the direction "②".
- 2) Remove the unit by pulling to the direction "③".

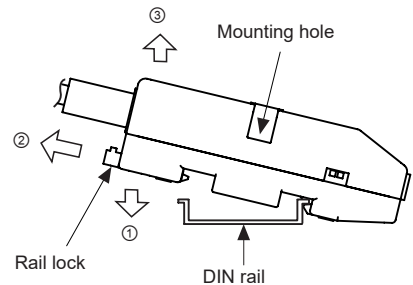

◎ Mounting the unit to panel

- 1) The unit is able to mount on the panel with two mounting holes.
- 2) For mounting this unit to panel, use M3 screws. Tightening torque is 0.4N.m.

※Multi-layer

Use long fixing screws and several units are fixed by stacking as multi-layer.

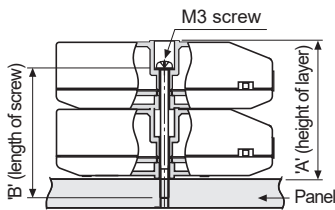

Number of layers(N)	'A' (23N+0.5)	'B' (23N-3)
1	23.5mm	20mm
2	46.5mm	43mm
3	69.5mm	66mm
4	92.5mm	89mm

SENSORS
FIELD INSTRUMENTS
CONTROLLERS
MOTION DEVICES
SOFTWARE

(A) Temperature Controllers
(B) SSRs
(C) Power Controllers
(D) Counters
(E) Timers
(F) Digital Panel Meters
(G) Indicators
(H) Converters
(I) Digital Display Units
(J) Sensor Controllers
(K) Switching Mode Power Supplies
(L) Recorders
(M) HMIs
(N) Industrial PC
(O) Field Network Devices

SCM-USU2I

Unit Description

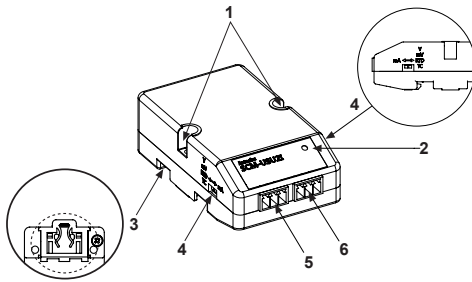

1. Mounting hole:

Used when the unit mounts to the panel.

2. Power indicator (red):

Turns ON the power indicator (red) when supplying the power.

3. Rail Lock:

Used when the unit mounts on DIN rail.

4. Input type selector:

Input type selector by each CH.
The left selector is for CH1 and the right one is for CH2 in the face.

V, mV, RTD, TC \longleftrightarrow mA
(default)

5. CH1 connector

6. CH2 connector

Input Sensor Type and Temperature Range

Input type		Display	Temperature range (°C)	Temperature range (°F)
Thermocouple	K(CA)	K(CA).H	-200 to 1350	-328 to 2462
		K(CA).L	-200.0 to 1350.0	-328.0 to 2462.0
	J(IC)	J(IC).H	-200 to 800	-328 to 1472
		J(IC).L	-200.0 to 800.0	-328.0 to 1472.0
	E(CR)	E(CR).H	-200 to 800	-328 to 1472
		E(CR).L	-200.0 to 800.0	-328.0 to 1472.0
	T(CC)	T(CC).H	-200 to 400	-328 to 752
		T(CC).L	-200.0 to 400.0	-328.0 to 752.0
	B(PR)	B(PR)	0 to 1800	32 to 3272
	R(PR)	R(PR)	0 to 1750	32 to 3182
	S(PR)	S(PR)	0 to 1750	32 to 3182
	N(NN)	N(NN)	-200 to 1300	-328 to 2372
	C(TT) ^{※1}	C(TT)	0 to 2300	32 to 4172
	G(TT) ^{※2}	G(TT)	0 to 2300	32 to 4172
L(IC)	L(IC).H	-200 to 900	-328 to 1652	
	L(IC).L	-200.0 to 900.0	-328.0 to 1652.0	
U(CC)	U(CC).H	-200 to 400	-328 to 752	
	U(CC).L	-200.0 to 400.0	-328.0 to 752.0	
Platinel II	PLII	0 to 1390	32 to 2534	
RTD	Cu50Ω	CU50 .L	-200.0 to 200.0	-200.0 to 392.0
	Cu100Ω	CU100 .L	-200.0 to 200.0	-200.0 to 392.0
	JPt100Ω	JPt100.H	-200 to 600	-328 to 1112
		JPt100 .L	-200 to 600.0	-328.0 to 1112.0
	DPt50Ω	DPt50 .L	-200 to 600.0	-328.0 to 1112.0
	DPt100Ω	DPt100.H	-200 to 600	-328 to 1112
		DPt100. L	-200.0 to 600.0	-328 to 1112.0
Nickel120Ω	NI120.H	-80 to 200	-112 to 392	
Analog	Voltage	0-10V	AV1	-9999 to 9999 (the display range varies depending on the decimal point setting.)
		0-5V	AV2	
		1-5V	AV3	
		0-1V	AV4	
		0-200mV	AmV1	
		-60-60mV	AmV2	
	Current	0-20mA	AmA1	
		4-20mA	AmA2	

※1: C (TT): Same as existing W5 (TT).

※2: G (TT): Same as existing W (TT).

2-CH USB Temperature Data Logger

Parameter Groups

1. Parameter 1 group

※Alarm□: Alarm1, Alarm2, Alarm3, Alarm4 ※CH□: CH1, CH2

Parameter	Display	Descriptions
Alarm output□ target CH	Alarm□ Target CH	Set the CH for monitoring by alarm. Setting range : CH1, CH2, CH1 or CH2, CH1 and CH2
Alarm output□ mode※1	Alarm□ Mode	Setting range : OFF, AL-1, AL-2
Alarm output□ low-limit SV CH□	Alarm□ Low_CH□	Setting range : Refer to the 'Input type and Temperature Range' ※When changing alarm operation mode, alarm output high/low-limit SV is automatically reset as min./max. value which has no alarm.
Alarm output□ high-limit SV CH□	Alarm□ High_CH□	
Alarm output□ hysteresis CH□	Alarm□ Hysteresis_CH□	Set the hysteresis of alarm output. Setting range : 1 to 100 (000.1 to 100.0)

※1: Alarm output mode

Mode	Name	Operations	Descriptions	
OFF	—	—	No alarm output	
AL-1	Absolute value high-limit alarm	 Alarm absolute value : Sets 90°C	 Alarm absolute value : Sets 110°C	Alarm output turns ON when PV is more than alarm absolute value.
AL-2	Absolute value low-limit alarm	 Alarm absolute value : Sets 90°C	 Alarm absolute value : Sets 110°C	Alarm output turns ON when PV is lower than alarm absolute value.

※H: Alarm output hysteresis

2. Parameter 2 group

Parameter	Display	Descriptions
CH□ input type	CH□ Input Type	Setting range: Refer to the 'Input type and temperature range'.
CH□ sensor temperature unit	CH□ Unit	°C↔°F ※Does not set in analog input.
CH□ low-limit input value	CH□ Low Range	Set the low-limit input value within analog input range. Setting range: Min. range to {high-limit input value (CH□ High Range)-F.S. 10% digit}
CH□ high-limit input value	CH□ High Range	Set the high-limit input value within analog input range. Setting range: {low-limit input value (CH□ Low Range)+F.S. 10% digit} to Max. range
CH□ decimal point place of scale value	CH□ Scale Dot	Within high/low-limit scale value, set the decimal point place for display value (PV). Setting range: 0, 0.0, 0.00, 0.000
CH□ low-limit scale value	CH□ Low Scale	Set display scale for analog low-limit input value (CH□ Low Range). Setting range : -9999 to 9999
CH□ high-limit scale value	CH□ High Scale	Set display scale for analog high-limit input value (CH□ High Range). Setting range : -9999 to 9999
CH□ analog display unit	CH□ Digital Unit	For analog input, set the display unit. Setting range : °C, °F, % , OFF
CH□ input correction	CH□ Input Bias	Input correction is to correct deviation occurred from temperature sensor. ※After input correcting, when present value (PV) is over the temperature range of the sensor, HHHH or LLLL is displayed. Setting range: -999 to 999 (-999.9 to 999.9)
CH□ input digital filter	CH□ Digital Filter	If the present value (PV) is fluctuating repeatedly by rapid change of input signal, stable recording is difficult. Input digital filter makes the present value stable. When input digital filter is set as 0.4 sec., input digital filter is applied for the input values for 0.4 sec. and the present value is may be different with the actual input value. Setting range: 0.1 to 120.0 (sec)

※□ : Enables to set in analog input.

SENSORS

FIELD INSTRUMENTS

CONTROLLERS

MOTION DEVICES

SOFTWARE

(A) Temperature Controllers

(B) SSRs

(C) Power Controllers

(D) Counters

(E) Timers

(F) Digital Panel Meters

(G) Indicators

(H) Converters

(I) Digital Display Units

(J) Sensor Controllers

(K) Switching Mode Power Supplies

(L) Recorders

(M) HMIs

(N) Industrial PC

(O) Field Network Devices

3. Parameter 3 group

Parameter	Display	Descriptions
Communication write enable/disable	Communications Write	Parameter setting is enable or disable by software (DAQMaster) setting. (reading parameter set value (Read) is always possible.) Enable : Enables changing and writing by parameters Disable : Disables changing and writing by parameters
Parameter reset	Parameter Initialize	Setting range : NO, YES

※Parameters reset by changing the parameter

Group	Parameter	Display	Reset parameters
Parameter 1 group	Alarm output <input type="checkbox"/> mode	Alarm <input type="checkbox"/> Mode	Alarm <input type="checkbox"/> High/Low_CH <input type="checkbox"/>
Parameter 2 group	CH <input type="checkbox"/> input type	CH <input type="checkbox"/> Input type	Alarm <input type="checkbox"/> High/Low_CH <input type="checkbox"/> , CH <input type="checkbox"/> Low/High Range, CH <input type="checkbox"/> Scale Dot, CH <input type="checkbox"/> Low/High Scale, CH <input type="checkbox"/> Digital Unit, CH <input type="checkbox"/> Input Bias
	CH <input type="checkbox"/> sensor temperature unit	CH <input type="checkbox"/> Unit	Alarm <input type="checkbox"/> High/Low_CH <input type="checkbox"/> , CH <input type="checkbox"/> Input Bias

■ Troubleshooting

Displays at software (DAQMaster).

Display	Description	Troubleshooting
OPEN	Flashes if input is broken or disconnected.	Check input sensor status.
HHHH	Flashes if present value is higher than the temperature range of the sensor.	When input is within the rated temperature range of the sensor, this display disappears.
LLLL	Flashes if present value is lower than the temperature range of the sensor.	

※When error displays and input is connected or within the rated temperature range of the sensor, the error display disappears and the unit operates normally.

■ Factory Default

Group	Parameter display	Factory default	Parameter display	Factory default
Parameter 1 group	Alarm <input type="checkbox"/> Target CH	Alarm1/2 : CH1 Alarm3/4 : CH2	Alarm <input type="checkbox"/> High_CH <input type="checkbox"/>	1350
	Alarm <input type="checkbox"/> Mode	Alarm1/3 : AL-1 Alarm2/4 : AL-2	Alarm <input type="checkbox"/> Hysteresis_CH <input type="checkbox"/>	1
	Alarm <input type="checkbox"/> Low_CH <input type="checkbox"/>	-200	—	—
Parameter 2 group	CH <input type="checkbox"/> Input Type	K (CA).H	CH <input type="checkbox"/> Low Scale	000.0
	CH <input type="checkbox"/> Unit	°C	CH <input type="checkbox"/> High Scale	100.0
	CH <input type="checkbox"/> Low Range	000.0	CH <input type="checkbox"/> Digital Unit	%
	CH <input type="checkbox"/> High Range	100.0	CH <input type="checkbox"/> Input Bias	0
	CH <input type="checkbox"/> Scale Dot	0	CH <input type="checkbox"/> Digital Filter	0.1
Parameter 3 group	Communications Write	Enable	Parameter Initialize	NO

2-CH USB Temperature Data Logger

■ Driver Installation

◎ USB Driver Installation

- 1) Visit our website (<http://www.autonics.com>) and download 'SCM-USU2I Driver'.
- 2) Unzip the downloaded file to the desired directory.
- 3) When connecting this product with a USB port, the 'Found New Hardware Wizard' appears automatically. At 'Do you want to search software by connecting 'Window Update'?', click 'No' and the following dialog box appears to start Driver installation. Select 'Install from a list or specific location (Advanced)' and click 'Next'.



- 4) Select 'Search for the best driver in these locations' and 'Include this location in the search'. Click 'Browse'.
- 5) The 'Browse Folder' dialog box appears. Select 'SCM-USU2I(AUTONICS) CDC USB to UART' and click 'Finish'. Click 'Next' to start the USB Driver installation.

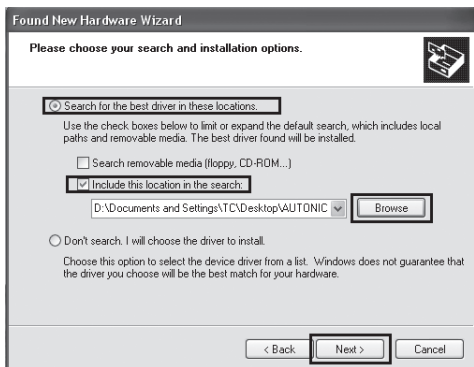

- 6) The 'Hardware Installation' dialog box appears. Click 'Continue Anyway' to proceed with installation.

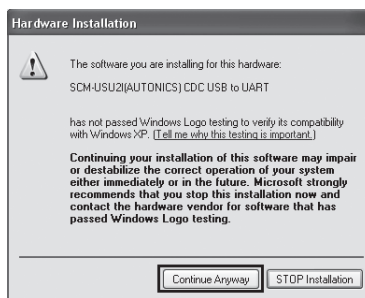

- 7) The following dialog box appears when the USB Driver is installed properly. Click 'Finish'.

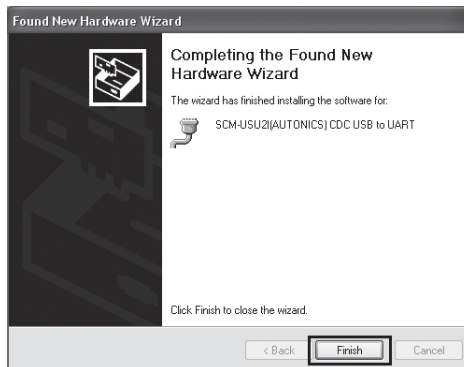

SENSORS
FIELD INSTRUMENTS
CONTROLLERS
MOTION DEVICES
SOFTWARE
(A) Temperature Controllers
(B) SSRs
(C) Power Controllers
(D) Counters
(E) Timers
(F) Digital Panel Meters
(G) Indicators
(H) Converters
(I) Digital Display Units
(J) Sensor Controllers
(K) Switching Mode Power Supplies
(L) Recorders
(M) HMIs
(N) Industrial PC
(O) Field Network Devices

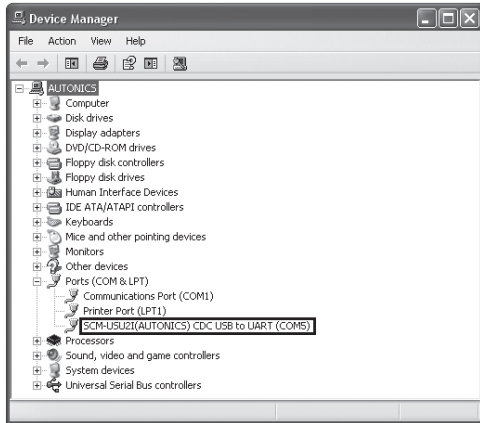

※Check that drivers are installed properly at 'Device Manager' after installing USB Driver and Serial Port Driver.

Select My Computer > Properties > Hardware tab > Device Manager.

Or select Start > Control Panel > System > Hardware tab > Device Manager.

Make sure that 'SCM-WF48 Driver(Autonics Corp)' is found and in 'Universal Serial Bus Controller' category and 'SCM-USU2(AUTONICS) CDC USB to UART(COM5)' is found in 'Ports (COM and LPT)'.

※This Driver Installation shows the procedure for Windows XP. There might be some differences in the specification above depending on OS.

■ Functions

○ High/Low Scale [CH Low Scale/CH High Scale]

For analog input, this function is set (-9999 to 9999) for particular high/low limit value in order to display high/low limit value of measurement input. If measurement inputs are 'a' and 'b' and particular values are 'A' and 'B', it will display $a=A$, $b=B$ as below graphs.

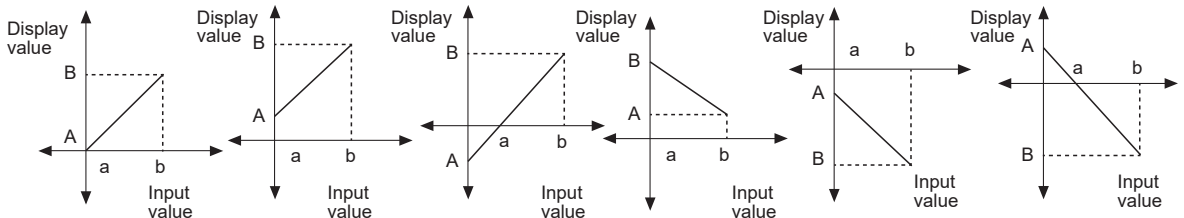

Display scale function is able to change display value for max./min. measured input by setting high limit scale [H - 5] and low limit scale [L - 5] in program mode.

※E.g.) Set high/low scale value (input range is 0 to 10V)

Low Scale=0.00
High Scale=5.00, 10.00, 15.00, 0.00

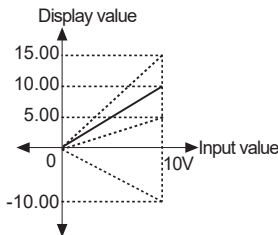

Low Scale=10.00
High Scale=-10.00

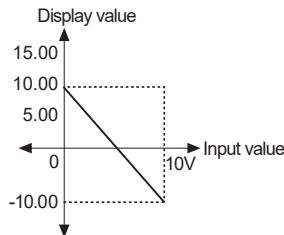

Low Scale=-5.00
High Scale=5.00

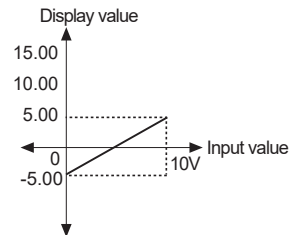

※ When changing input type, high/low scale is changed as factory default.

2-CH USB Temperature Data Logger

■ Proper Usage

◎ Cautions during use

- Follow instructions in 'Cautions during use'. Otherwise, It may cause unexpected accidents.
- Check the polarity of the terminals before wiring the temperature sensor.
For RTD temperature sensor, wire it as 3-wire type, using cables in same thickness and length.
For thermocouple (CT) temperature sensor, use the designated compensation wire for extending wire.
- Keep away from high voltage lines or power lines to prevent inductive noise.
In case installing power line and input signal line closely, use line filter or varistor at power line and shielded wire at input signal line.
Do not use near the equipment which generates strong magnetic force or high frequency noise.
- Do not apply excessive power when connecting or disconnecting the connectors of the product.
- When changing the input sensor, turn off the power first before changing.
After changing the input sensor, modify the value of the corresponding parameter.
- Do not overlapping communication line and power line.
Use twisted pair wire for communication line and connect ferrite bead at each end of line to reduce the effect of external noise.
- Use USB cable of designated standard, and do not use extension cable.
Using cable over 3m requires noise countermeasures.
- Use USB hub with the external power supply.
- When connecting multiple SCM-USU21 units to a PC, number of COM port goes up in sequential order and it takes some time to identify and assign number of COM port.
- Make a required space around the unit for radiation of heat.
For accurate temperature measurement, warm up the unit over 20 min after turning on the power.
- Make sure that power supply voltage reaches to the rated voltage within 2 sec after supplying power.
- Do not wire to terminals which are not used.
- Do not connect or disconnect USB cable quickly and repeatedly while communicating.
It may cause damage or malfunction of the product and PC.
- This unit may be used in the following environments.
 - ① Indoors (in the environment condition rated in 'Specifications')
 - ② Altitude max. 2,000m
 - ③ Pollution degree 2
 - ④ Installation category I

SENSORS
FIELD INSTRUMENTS
CONTROLLERS
MOTION DEVICES
SOFTWARE
(A) Temperature Controllers
(B) SSRs
(C) Power Controllers
(D) Counters
(E) Timers
(F) Digital Panel Meters
(G) Indicators
(H) Converters
(I) Digital Display Units
(J) Sensor Controllers
(K) Switching Mode Power Supplies
(L) Recorders
(M) HMIs
(N) Industrial PC
(O) Field Network Devices