

Rectangular Photoelectric Sensors



BJX Series PRODUCT MANUAL

For your safety, read and follow the considerations written in the instruction manual, other manuals and Autonics website.

The specifications, dimensions, etc. are subject to change without notice for product improvement. Some models may be discontinued without notice.

Features

- Long sensing distance with high quality lens
: Through-beam type 30 m, diffuse reflective type 1 m, polarized retroreflective type 3 m (MS-2A)
- M.S.R. (Mirror Surface Rejection) function (Polarized retroreflective type)
- Compact size : W 11 × H 32 × L 20 mm
- Switch for selecting Light ON/Dark ON mode
- Built-in sensitivity adjustment adjuster
- Reverse power protection circuit, output short overcurrent protection circuit
- Mutual interference prevention function (except through-beam type)
- Excellent noise immunity and minimal influence from ambient light
- IP65 protection rating (IEC standard)

Safety Considerations

- Observe all 'Safety Considerations' for safe and proper operation to avoid hazards.
- ⚠ symbol indicates caution due to special circumstances in which hazards may occur.

⚠ Warning Failure to follow instructions may result in serious injury or death.

- 01. Fail-safe device must be installed when using the unit with machinery that may cause serious injury or substantial economic loss. (e.g., nuclear power control, medical equipment, ships, vehicles, railways, aircraft, combustion apparatus, safety equipment, crime/disaster prevention devices, etc.)**
Failure to follow this instruction may result in personal injury, economic loss or fire.
- 02. Do not use the unit in the place where flammable/explosive/corrosive gas, high humidity, direct sunlight, radiant heat, vibration, impact or salinity may be present.**
Failure to follow this instruction may result in explosion or fire.
- 03. Do not disassemble or modify the unit.**
Failure to follow this instruction may result in fire.
- 04. Do not connect, repair, or inspect the unit while connected to a power source.**
Failure to follow this instruction may result in fire.
- 05. Check 'Connections' before wiring.**
Failure to follow this instruction may result in fire.

⚠ Caution Failure to follow instructions may result in injury or product damage.

- 01. Use the unit within the rated specifications.**
Failure to follow this instruction may result in fire or product damage.
- 02. Use a dry cloth to clean the unit, and do not use water or organic solvent.**
Failure to follow this instruction may result in fire.

Cautions during Use

- Follow instructions in 'Cautions during Use'. Otherwise, It may cause unexpected accidents.
- When connecting an inductive load such as DC relay or solenoid valve to the output, remove surge by using diodes or varistors.
- Use the product after 0.5 sec of the power input.
When using a separate power supply for the sensor and load, supply power to the sensor first.
- The power supply should be insulated and limited voltage/current or Class 2, SELV power supply device.
- Wire as short as possible and keep it away from high voltage lines or power lines to prevent surge and inductive noise.
- When using switching mode power supply (SMPS), ground F.G. terminal and connect a condenser between 0V and F.G. terminal to remove noise.
- When using a sensor with a noise-generating equipment (e.g., switching regulator, inverter, and servo motor), ground F.G. terminal of the equipment.
- This unit may be used in the following environments.
 - Indoors (in the environment condition rated in 'Specifications')
 - Altitude max. 2,000 m
 - Pollution degree 3
 - Installation category II

Product Components

Sensing type	Through-beam	Polarized retroreflective	Diffuse reflective
Product components	Product, instruction manual		
Reflector	-	MS-2A	-
Adjustment screwdriver	× 1	× 1	× 1
Bracket A or B ⁰¹⁾	× 2	× 1	× 1
M3 bolt	× 4	× 2	× 2

01) Cable type, cable connector type: Bracket A, connector type: Bracket B

Ordering Information

This is only for reference, the actual product does not support all combinations. For selecting the specified model, follow the Autonics website.

BJX ① - ② ③ ④ - ⑤ - ⑥

① Sensing distance

Number: Sensing distance (unit: mm)
Number+M: Sensing distance (unit: m)

② Sensing type

T: Through-beam
P: Polarized retroreflective
D: Diffuse reflective

③ Power supply

D: 10 - 30 VDC≒

④ Output

T: Solid state (transistor)

⑤ Connection

No mark: Cable type
C: Connector type

⑥ Control output

No mark: NPN open collector output
P: PNP open collector output

Sold Separately

- Reflector: MS Series
- Bracket A, B
- Retroreflective tape: MST Series
- M8 connector cable: CID(H)408-□, CLD(H)408-□

Cautions during Installation

- Be sure to install this product by following the usage environment, location, and specified ratings. Consider the listed conditions below.
 - Installation environment and background (reflected light)
 - Sensing distance and sensing target
 - Direction of target's movement
 - Characteristic curves
- When installing multiple sensors closely, it may result in malfunction due to mutual interference.
- For installation, tighten the screw with a torque of 0.5 N·m. Mount the brackets correctly to prevent the twisting of the sensor's optical axis.
- Do not impact with a hard object or bend the cable excessively. That could decrease the product's water resistance.
- Use this product after the test. Check whether the indicator works appropriately for the positions of the detectable object.

Through-beam	Retroreflective	Reflective
Emitter - Receiver: Install to face each other	Sensor - Reflector: At least 0.1 m apart, install to face each other (parallel with the sensing side of the unit)	Sensor - Sensing target: Install to face each other (parallel with the sensing side of the unit)

Setting Operation Mode

- Be sure to set the mode before power-on.
- Use the offered adjustment screwdriver. Do NOT turn with excessive force to prevent product damage.

L: Light ON mode	D: Dark ON mode

Operation Timing Chart and Indicators

Light ON mode

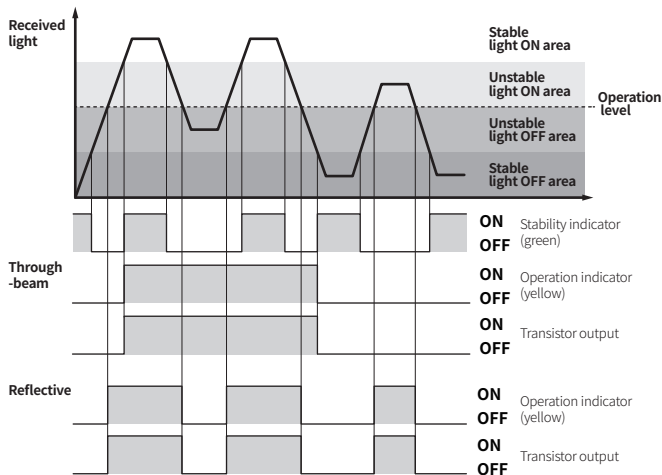

- In Dark ON mode, the waveforms are reversed.
- Operation indicator and transistor output differ from the sensing method.

Connections

Cable type: Emitter

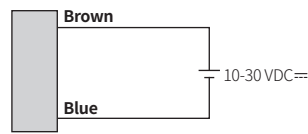

Cable type: Receiver, Polarized retroreflective, Diffuse reflective type

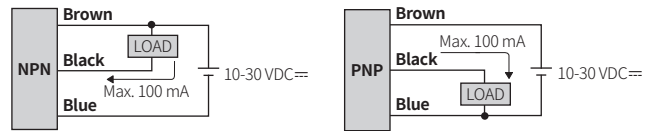

Connector type



Pin	Color	Function
①	Brown	+V
②	-	-
③	Blue	0V
④	Black	OUT

Connector pin ③ is N.C (not connected) terminal for the emitter.

Circuit

NPN open collector output

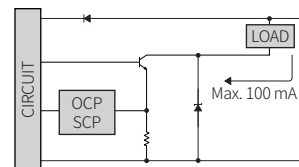

PNP open collector output

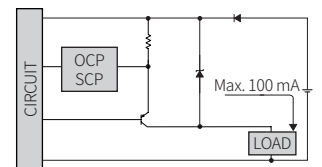

- OCP (over current protection), SCP (short circuit protection)
- If short-circuit the control output terminal or supply current over the rated specification, normal control signal is not output due to the protection circuit.

Sensitivity Adjustment

- Set the adjuster for stable Light ON area, minimizing the effect of the installation environment.
- Use the offered adjustment screwdriver. Do NOT turn with excessive force to prevent product damage.
- The steps below are based on Light ON mode.

STEP	Status	Description
01	Received	Turn the adjuster from MIN (−) to MAX (+) sensitivity and check the position (A) where the operation indicator activates under the light ON area.
02	Interrupted	Turn the adjuster from (A) to MAX (+) and check the position (B) where the operation indicator activates under the light OFF area. If the operation indicator does NOT activate at the MAX (+, maximum sensitivity): MAX = (B).
03	-	Set the adjuster at the mid position between (A) and (B) for optimal sensitivity.

Dimensions

- Unit: mm, For the detailed drawings, follow the Autonics website.
- This dimensions shows the cable type and connector type. Refer to the 'Specifications' for the core, wiring, and connector spec.

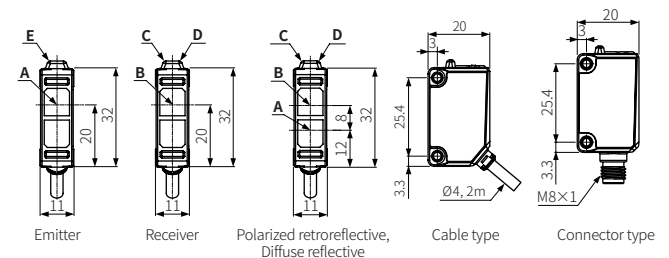

A	Optical axis of emitter	D	Stability indicator (green)
B	Optical axis of receiver	E	Power indicator (red)
C	Operation indicator (yellow)		

■ Reflector (MS-2A)

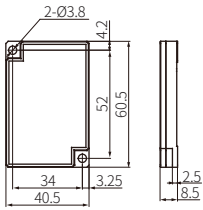

■ Bracket A

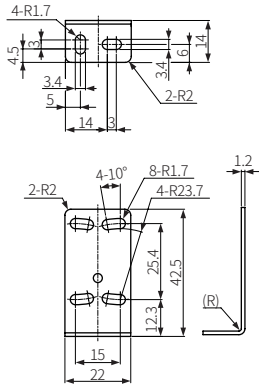

■ Bracket B (BJP SERIES BRACKET B)

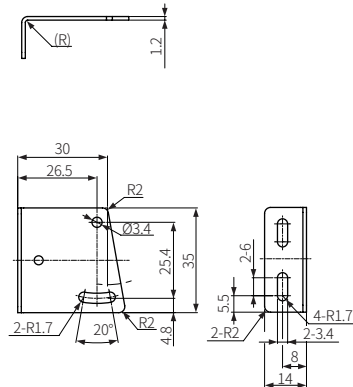

Sold Separately: M8 Connector Cable

• For detailed information, refer to the 'M8/M12 Connector Cable' manual.

Appearance	Power	Connector 1	Connector 2	Length	Feature	Model
	DC	M8 (Socket-Female) 4-pin	4-wire	2 m	PVC	CID408-2
				5 m		CID408-5
	DC	M8 (Socket-Female) 4-pin	4-wire	2 m	Oil resistant PVC	CIDH408-2
				5 m		CIDH408-5
	DC	M8 (Socket-Female) 4-pin, L type	4-wire	2 m	PVC	CLD408-2
				5 m		CLD408-5
	DC	M8 (Socket-Female) 4-pin, L type	4-wire	2 m	Oil resistant PVC	CLDH408-2
				5 m		CLDH408-5

Specifications

Model	BJX□-TDT-□-□	BJX3M-PDT-□-□	BJX□-DDT-□-□
Sensing type	Through-beam	Polarized retroreflective	Diffuse reflective
Sensing distance	10 m 15 m 30 m	3 m ⁽⁰¹⁾	100 mm ⁽⁰²⁾ 300 mm ⁽⁰²⁾ 1 m ⁽⁰³⁾
Sensing target	Opaque materials	Opaque materials	Opaque materials, translucent materials
Min. sensing target	≥ Ø 15 mm	≥ Ø 75 mm	-
Hysteresis	-	-	≤ 20% of sensing distance
Response time	≤ 1 ms		
Light source	Red LED Infrared	Red LED	Infrared Red LED Red LED
Peak emission wavelength	660 nm 850 nm	660 nm	660 nm 850 nm 660 nm 660 nm
Sensitivity adjustment	YES (Adjuster)	YES (Adjuster)	YES (Adjuster)
Mutual interference prevention	-	YES	YES
Operation mode	Light ON mode - Dark ON mode selectable (Adjuster)		
Indicator	Operation indicator (yellow), stability indicator (green), power indicator (red) ⁽⁰⁴⁾		
Approval	CE RoHS REACH	CE RoHS REACH	CE RoHS REACH

01) Reflector (MS-2A)

02) Non-glossy white paper 100 × 100 mm





03) Non-glossy white paper 300 × 300 mm

04) Only for the emitter

Unit weight (packaged)	Through-beam	Polarized retroreflective	Diffuse reflective
Cable type	≈ 95 g (≈ 145 g)	≈ 50 g (≈ 115 g)	≈ 50 g (≈ 100 g)
Connector type	≈ 12 g (≈ 65 g)	≈ 6 g (≈ 75 g)	≈ 6 g (≈ 60 g)
Power supply	10-30 VDC≐ ± 10% (ripple P-P: ≤ 10%)		
Current consumption	It depends on the sensing type		
Through-beam	Emitter: ≤ 20 mA, receiver: ≤ 20 mA		
Reflective	≤ 30 mA		
Control output	NPN open collector output / PNP open collector output model		
Load voltage	≤ 30 VDC≐		
Load current	≤ 100 mA		
Residual voltage	NPN: ≤ 1 VDC≐, PNP: ≤ 2 VDC≐		
Protection circuit	Reverse power protection circuit, output short overcurrent protection circuit		
Insulation resistance	≥ 20 MΩ (500 VDC≐ megger)		
Noise immunity	± 240 VDC≐ the square wave noise (pulse width: 1 μs) by the noise simulator		
Dielectric strength	Between the charging part and the case: 1,000 VAC~ 50/60 Hz for 1 min		
Vibration	1.5 mm double amplitude at frequency of 10 to 55 Hz in each X, Y, Z direction for 2 hours		
Shock	500 m/s ² (≈ 50 G) in each X, Y, Z direction for 3 times		
Ambient illuminance (receiver)	Sunlight: ≤ 11,000 lx, incandescent lamp: ≤ 3,000 lx		
Ambient temperature	-25 to 60 °C, storage: -40 to 70 °C (no freezing or condensation) ⁽⁰¹⁾		
Ambient humidity	35 to 85 %RH, storage: 35 to 85 %RH (no freezing or condensation)		
Protection rating	IP65 (IEC standard)		
Connection	Cable type / Connector type model		
Cable spec.	Ø 4 mm, 3-wire (Emitter: 2-wire), 2 m		
Wire spec.	AWG26 (0.52 mm, 20-core), insulator outer diameter: Ø 1 mm		
Connector	M8 4-pin plug type		
Material	Case: PC, CAP: PC, sensing part: PMMA		

01) UL approved ambient temperature: 40 °C

Sold Separately: Reflector MS Series

Appearance	Size (W × H)	Reflectance	Sensing type	Model
	40.5 × 60.5 mm	Typical reflectivity	Retroreflective	MS-2
		Typical reflectivity	Polarized retroreflective	MS-2A
		High reflectivity	Polarized retroreflective	MS-2S
	81.5 × 60.5 mm	Typical reflectivity	Retroreflective	MS-3
		High reflectivity	Polarized retroreflective	MS-3S
	29.3 × 38 mm	Typical reflectivity	Retroreflective	MS-4
	15.4 × 24 mm	Typical reflectivity	Retroreflective	MS-5
	13.7 × 23 mm	Typical reflectivity	Retroreflective	MS-6

- Material: PMMA / ABS (front part / rear part)
- Installation: Bolt mounting

Dimensions

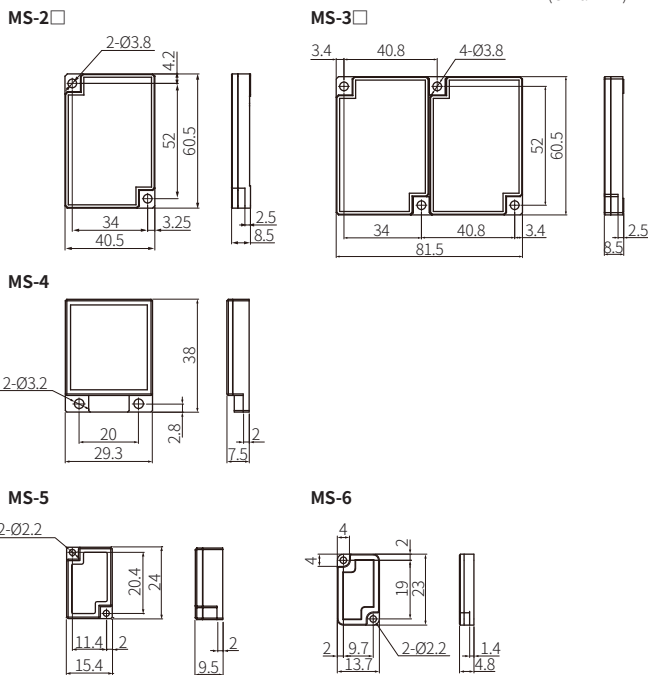

(Unit: mm)



Cautions during Installation

- Select a reflector size that is suitable for the installation space and operating environment of the sensors.
- In general, a bigger size of the reflector results in a longer sensing distance.
- Reflectors with high reflectivity increase the sensing distance compared to typical reflectors.
- The reflectance may vary depending on the operating environment for the sensors.

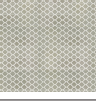
Sold Separately: Retroreflective Tape MST Series

Appearance	Size (W × H)	Approval	Packaged unit	Sensing type	Model
	50 × 50 mm	ERC	10	• Retroreflective • Polarized retroreflective	MST-50-10
	100 × 100 mm	ERC	5	• Retroreflective • Polarized retroreflective	MST-100-5
	200 × 200 mm	ERC	2	• Retroreflective • Polarized retroreflective	MST-200-2

- Material: PMMA / PC / Acrylic (surface film / prism layer / adhesive layer)
- Ambient temperature: -35 to 65 °C (temperature for adhesion: 10 to 30 °C)
- Installation: Tape cutting (installation distance: ≥ 20 mm)

Reflectance of MST Series

Series	Sensing type	MST-50-10	MST-100-5	MST-200-2
BTS	Retroreflective	95%	100%	100%
BM		70%	110%	170%
BMS		90%	120%	190%
BEN		90%	130%	140%
BX		90%	100%	110%
BJ	Polarized retroreflective	40%	60%	100%
BJR		35%	45%	55%
BJX		35%	45%	55%
BH		60%	80%	140%
BEN		70%	90%	120%
BX		30%	40%	60%
BRQ		40%	50%	80%
BRQP (plastic material type)		40%	80%	85%
BRQS (side sensing type)		25%	30%	35%

Dimensions

(Unit: mm)

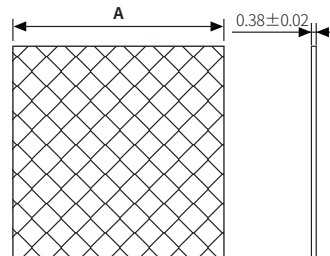

Model	A
MST-50-10	□ 50
MST-100-5	□ 100
MST-200-2	□ 200

Cautions during Installation

- Select a retroreflective tape that is suitable for the installation space and operating environment of the sensors.
- In general, a bigger size of retroreflective tape results in a longer sensing distance.
- Be sure to check the reflectance of the MST series for proper use.
- The reflectance may vary depending on the operating environment for the sensors.
- Before applying the tape, clean the adhesive side of the reflective tape with a dry cloth.
- Do not press or damage the surface of the retroreflective tape.
- Regularly clean the tape to maintain optimal performance, using only neutral detergents. Do not use chemical solvents.

Characteristic Curves: Through-beam Type

■ Sensing area

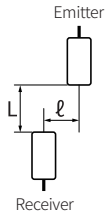

• BJX10M-TDT-C-P

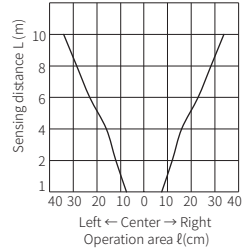

• BJX15M-TDT

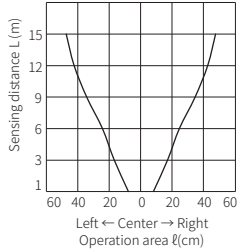

• BJX30M-TDT-C

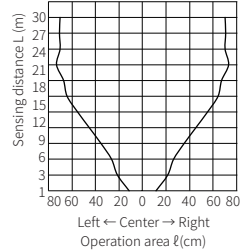

■ Emitter angle

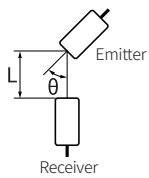

• BJX10M-TDT-C-P

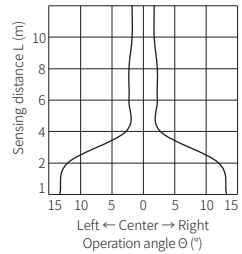

• BJX15M-TDT

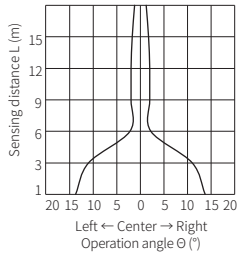

• BJX30M-TDT-C

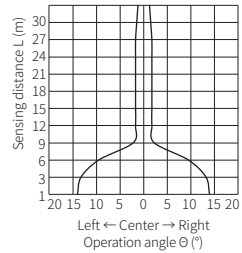

Characteristic Curves: Polarized Retroreflective Type

■ Sensing area

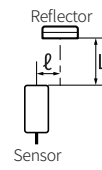

• BJX3M-PDT

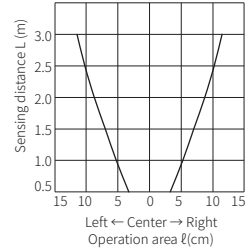

■ Sensor angle

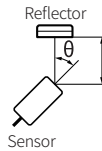

• BJX3M-PDT

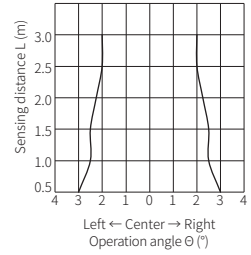

■ Reflector angle

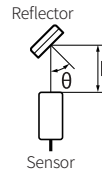

• BJX3M-PDT

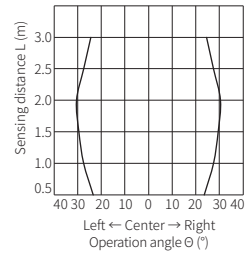

Characteristic Curves: Diffuse Reflective Type

■ Sensing area

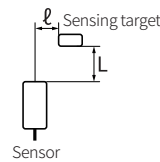

• BJX100-DDT-C

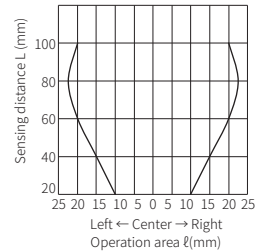

• BJX300-DDT

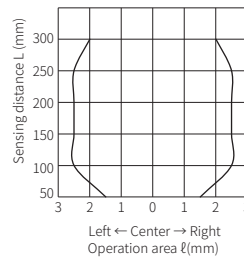

• BJX1M-DDT-C

