

DIAGONAL14 F/TY

- reduced glare effect
- best for furniture applications
- zmniejszony efekt olśnienia
- głównie do zastosowania meblowego



max 14 mm



recessed
wpustowy



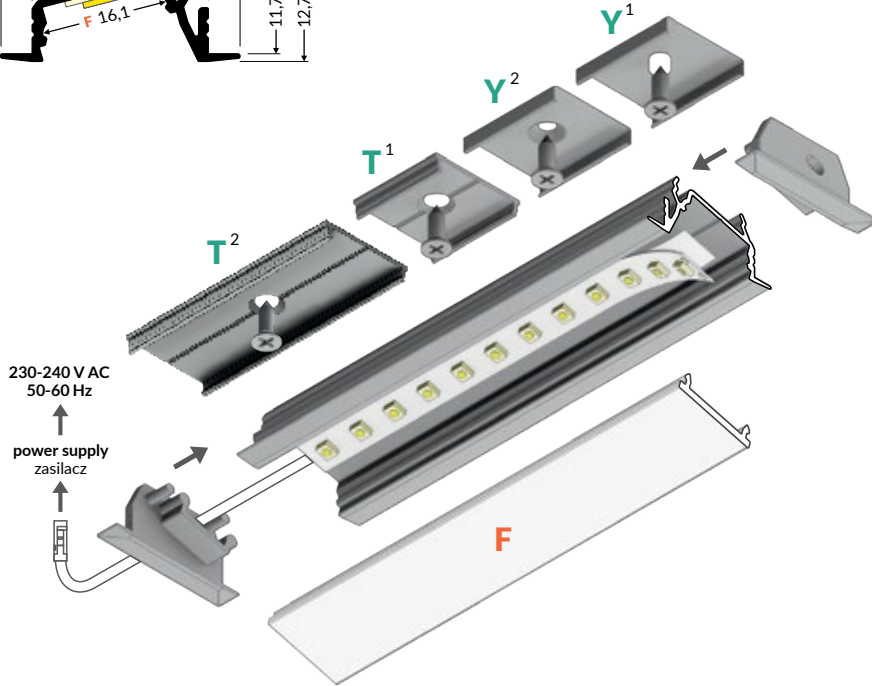
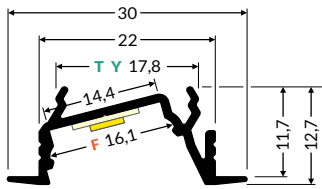

white painted
biały malowany
H5020001



anodized
anodowany
H5020020P



black anodized
czarny anodowany
H5020021



raw aluminium
surowe aluminium
H5020000P

INDEX = length 2000 mm
Quantities, package and other length available > check the pricelist. Technical details > 8-18
INDEKS = długość 2000 mm
Ilości, opakowanie, inne dostępne długości > patrz cennik. Szczegóły techniczne > 8-18

Y¹

Y flexible mounting
plate > 101
uchwyt Y sprężysty
> 101

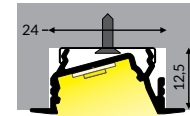

Y²

cone Y flexible mounting
plate > 101
uchwyt Y sprężysty cone
> 101

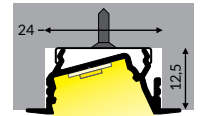

T¹

T mounting plate
> 98
uchwyt T > 98

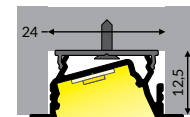

T²

T connector 180 deg
> 98
łącznik T 180 st > 98

F

F click diffuser > 96
klosz F klik > 96

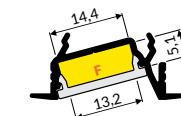

F

F click diffuser > 96
klosz F klik > 96

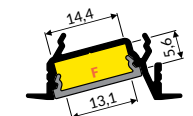

DIAGONAL14 end cap with hole
material: ABS
zaślepka DIAGONAL14 z otworem
material: ABS



white / biały
H5999901
silver / srebrny
H5999940
black / czarny
H5999902
grey / szary
H5999922

Quantities and package > check the pricelist
Technical details > 8-18
Ilości i opakowanie > patrz cennik
Szczegóły techniczne > 8-18

