

GROOVE14 EF/TY

- used mainly in furniture
- many accessories available

- głównie do zastosowania meblowego
- wiele akcesoriów do wyboru



max 14 mm



recessed
wpustowy



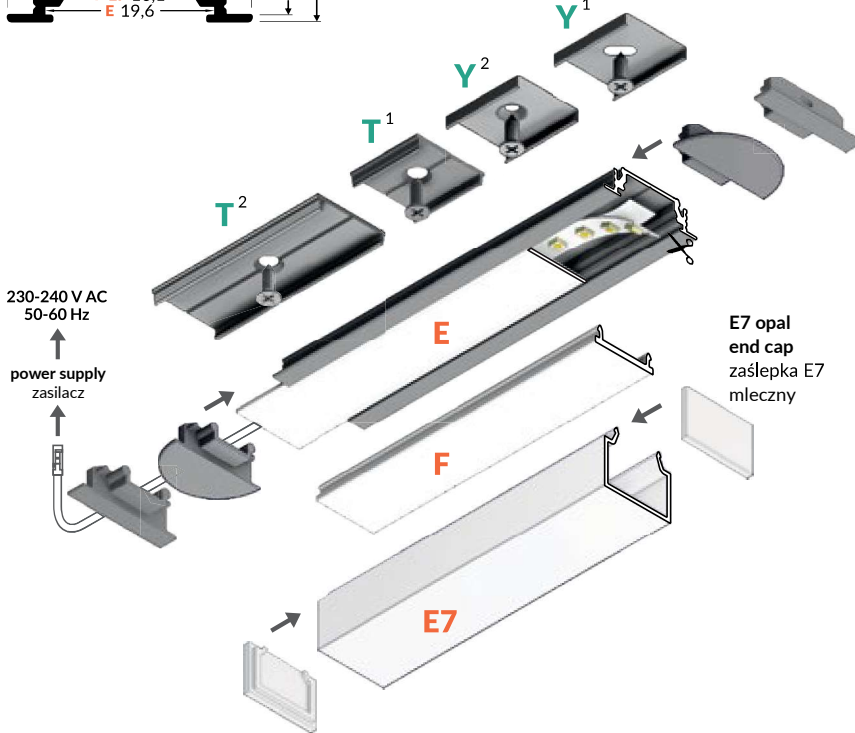
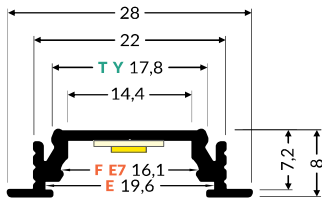

white painted
biały malowany
A3020001



anodized
anodowany
A3020020P



black anodized
czarny anodowany
A3020021



raw aluminium
surowe aluminium
A3020000P

INDEX = length 2000 mm
Quantities, package and other length available > check the pricelist. Technical details > 8-18
INDEKS = długość 2000 mm
Ilości, opakowanie, inne dostępne długości > patrz cennik. Szczegóły techniczne > 8-18

Y¹

Y flexible mounting
plate > 101
uchwyt Y sprężysty
> 101

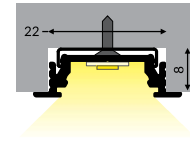

Y²

cone Y flexible mounting
plate > 101
uchwyt Y sprężysty cone
> 101

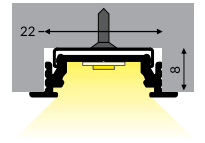

T¹

T mounting plate > 98
uchwyt T > 98

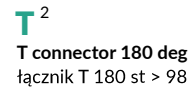

T²

T connector 180 deg > 98
łącznik T 180 st > 98

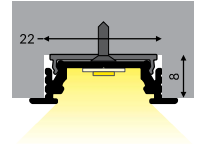

E

E slide diffuser > 96
klosz E wsuwany > 96

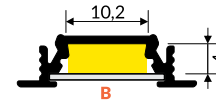

F

F click diffuser > 96
klosz F klik > 96

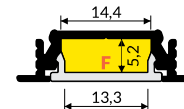

F

F click diffuser > 96
klosz F klik > 96

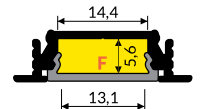

E7

E7 click diffuser > 96
klosz E7 klik > 96

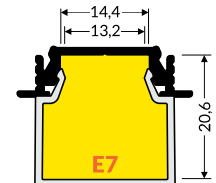

E7 opal end cap > 96
zaślepka E7
mleczny > 96



GROOVE14 end cap
gen2 with hole
material: ABS
zaślepka GROOVE14
gen2 z otworem
material: ABS



white / biały
A3970001
silver / srebrny
A3970040
black / czarny
A3970002
grey / szary
A3970022

GROOVE14 end cap
gen2 SQ with hole
material: ABS
zaślepka GROOVE14
gen2 SQ z otworem
material: ABS



white / biały
A3980001
silver / srebrny
A3980040
black / czarny
A3980002
grey / szary
A3980022

GROOVE14 connector 90 deg
material: aluminium
łącznik GROOVE14 90 st
material: aluminium



white painted
biały malowany
A3990001

anodized
anodowany
A3990020

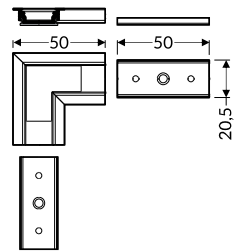

black anodized
czarny anodowany
A3990021

Quantities and package > check the pricelist
Technical details > 8-18
Ilości i opakowanie > patrz cennik
Szczegóły techniczne > 8-18