

Specificatii

Tensiune nominala	6V		
Capacitate nominala (20h)	8,0Ah		
Dimensiuni	Lungime	151 ± 1,5mm	
	Latime	34 ± 1mm	
	Inaltime carcasa	94 ± 1mm	
	Inaltime totala (cu borne)	100 ± 1mm	
Greutate	Approx 1,28kg		
Tip Borna	T1, T2		
Material carcasa	ABS		
Capacitate	8,0Ah / 0,40A	20Hr, 1,75V/cell, 25°C	
	7,5Ah / 0,75A	10Hr, 1,75V/cell, 25°C	
	6,85Ah / 1,37A	5Hr, 1,75V/cell, 25°C	
	5,82Ah / 1,94A	3Hr, 1,75V/cell, 25°C	
	5,24Ah / 5,24A	1Hr, 1,60V/cell, 25°C	
Curent maxim de descarcare	105A (5s)		
Rezistenta interna	Approx 10mΩ		
Interval temp. de utilizare	Descarcare: -15 ÷ 50°C		
	Incarcare: -10 ÷ 50°C		
	Depozitare: -20 ÷ 50°C		
Temp. nominala de utilizare	25 ± 3°C		
Utilizare ciclica	Curent initial de incarcare: <2,10A. Tensiunea de incarcare: 7,25V ÷ 7,50V la 25°C. Coef. de corectie cu temperatura: -15mV /		
Utilizare tampon (stand-by)	Curent initial de incarcare: <2,10A. Tensiunea de incarcare: 6,75V ÷ 6,90V at 25°C. Coef. de corectie cu temperatura: -9mV /		
Influenta temperaturii asupra capacitatii	40°C	102%	25°C 100%
	0°C	85%	-15°C 65%
Autodescercare la 25°C	3 luni	Capacitate remanenta: 91%	
	6 luni	Capacitate remanenta: 82%	
	12 luni	Capacitate remanenta: 65%	

Utilizari si caracteristici

Tehnologie: VRLA

Surse neinteruptibile de tensiune (UPS)

Sisteme electrice de alimentare (EPS)

Sisteme de semnalizare aeriene si feroviare

Iluminat de siguranta

Centrale electrice

Sisteme de alarma si securitate

Surse de alimentare cu C.C.

EN 60896-21,-22

Durata de viata proiectata: 5 ani

Eurobat: Standard Comercial

Bateriile din gama FOTON FS pot fi stocate

pina la 6 luni la 25°C dupa care este

recomandata o incarcare de improspatare

Descarcare cu curent constant (Amperi) la 25°C

Ufinal/timp	5min	10min	15min	30min	60min	2h	3h	4h	5h	10h	20h
4.80V	30.6	19.4	15.1	8.52	5.24	2.87	1.98	1.64	1.40	0.76	0.41
4.95V	29.6	18.8	14.8	8.35	5.16	2.85	1.97	1.63	1.39	0.75	0.40
5.10V	28.4	18.0	14.2	8.09	5.03	2.82	1.96	1.62	1.38	0.75	0.40
5.25V	27.2	17.2	13.7	7.90	4.93	2.78	1.94	1.61	1.37	0.75	0.40
5.40V	25.7	16.3	13.0	7.61	0.78	2.71	1.89	1.56	1.33	0.73	0.39

Descarcare cu putere constanta (Watts/bloc) la 25°C

Ufinal/timp	5min	10min	15min	30min	60min	2h	3h	4h	5h	10h	20h
4.80V	171	109	86.2	48.8	30.3	16.8	11.8	9.77	8.33	4.55	2.44
4.95V	165	106	84.1	47.8	29.9	16.7	11.7	9.71	8.28	4.53	2.43
5.10V	159	102	81.0	46.4	29.1	16.5	11.6	9.64	8.22	4.51	2.41
5.25V	152	97.2	78.3	45.3	28.5	16.3	11.5	9.58	8.17	4.48	2.40
5.40V	143	91.7	74.1	43.6	27.7	15.9	11.2	9.29	7.92	4.39	2.35

Dimensiuni exterioare (mm)

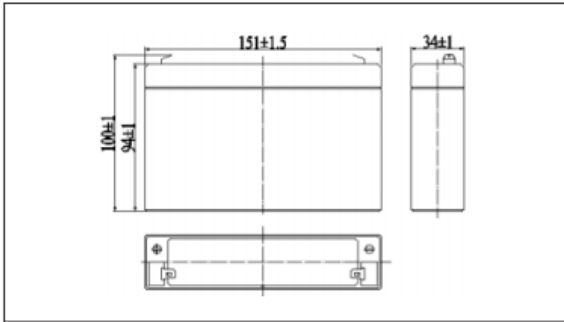

Tip Borna (mm)

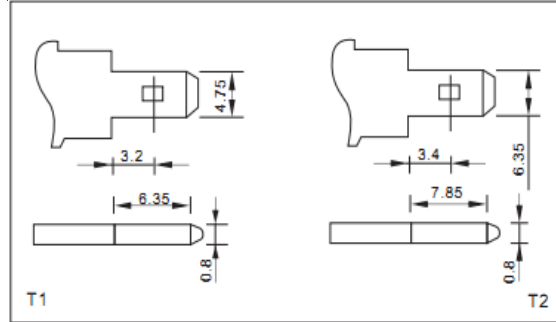

Caracteristici de descarcare (25°C)

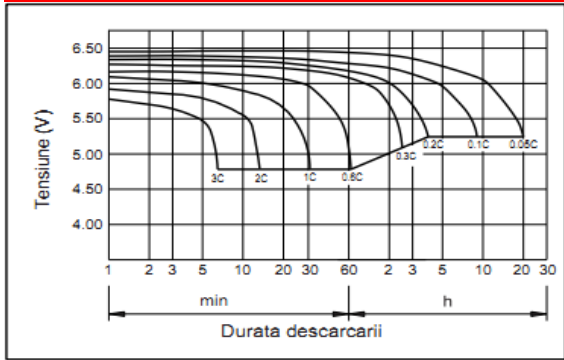

Caracteristici de incarcare (25°C)

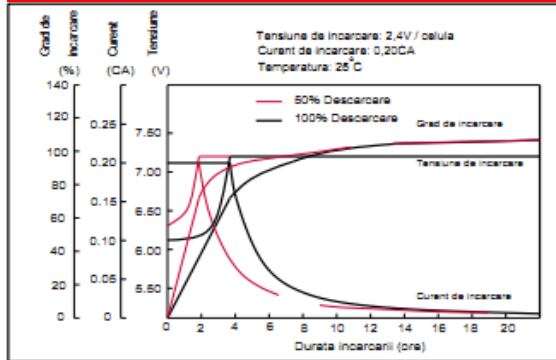

Efectul temperaturii asupra capacitatii

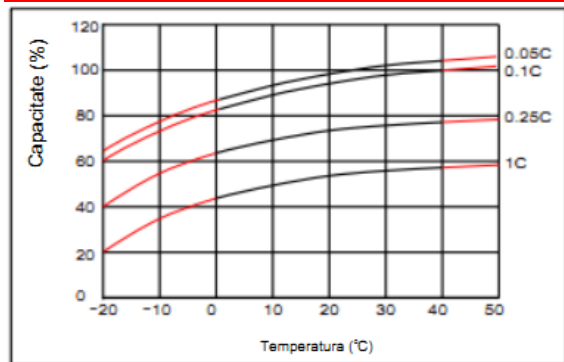

Durata de viata in functie de temperatura

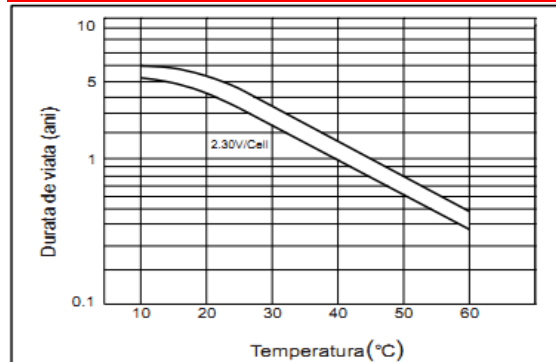

Numar de cicluri vs D.O.D (25°C)

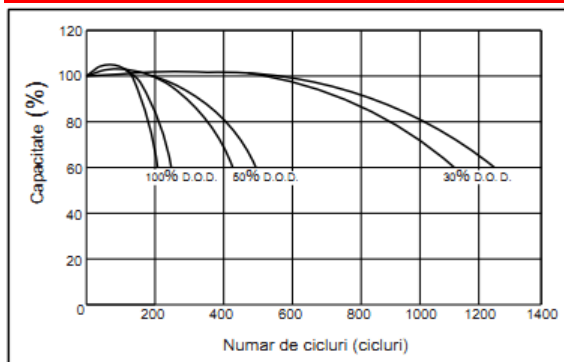

Relatia tensiune la borne / capacitate (25°C)

