

NP12-65Ah 12V65Ah

Specifications

Nominal Voltage		12V
Rated capacity (10 hour rate)		65Ah
Dimensions	Length	350±2mm(13.78inch)
	Width	166±2mm(5.54inch)
	Height	179±2mm(7.05inch)
	Total Height	179±2mm(7.05inch)
Approx. Weight		20.4kg(45.0lbs)±3%



Outer dimensions (mm)

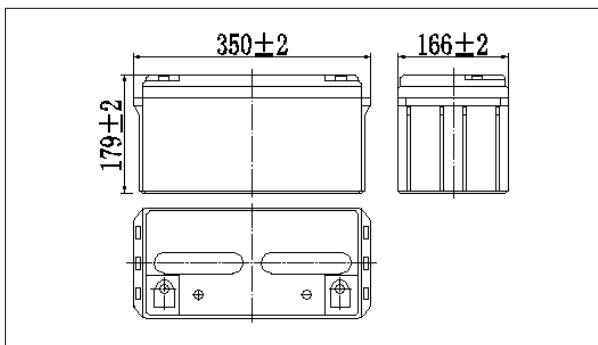

Terminal Type (mm)

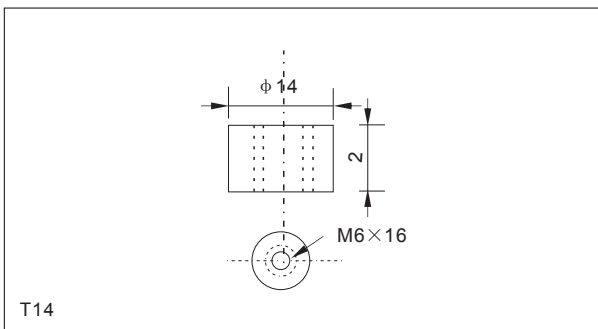

Characteristics

Capacity (25°C)	10HR(10.8V)	65Ah
	3HR(10.8V)	48Ah
	1HR(10.5V)	36Ah
Terminal type		T14
Internal resistance (Fully charged, 25°C)		Approx. 6.5m Ω
Capacity affected by temperature (10HR)	40°C	102%
	25°C	100%
	0°C	85%
	-15°C	65%
Self-discharge (25°C)	3 months	Remaining Capacity:91%
	6 months	Remaining Capacity:82%
	12 months	Remaining Capacity:65%
Nominal operating temperature		25°C ±3°C(77°F ±5°F)
Operating temperature range	Discharge	-15°C~50°C(5°F~122°F)
	Charge	-10°C~50°C(14°F~122°F)
	Storage	-20°C~50°C(-4°F~122°F)
Float charging voltage(25°C)		13.50 to 13.80V Temperature compensation: -18mV/°C
Cyclic charging voltage(25°C)		14.50 to 15.00V Temperature compensation: -30mV/°C
Maximum charging current		19.5A
Maximum discharge current		650A(5 sec.)
Designed floating life(20°C)		10years

Construction

Component	Positive plate	Negative plate	Container	Cover	Separator	Electrolyte	Safety valve	Terminal
Raw material	Lead dioxide	Lead	ABS	ABS	AGM	Sulfuric acid	Rubber	Copper

Constant Current Discharge Characteristics Unit:A(25°C,77°F)

F.V/Time	10min	15min	30min	60min	2h	3h	4h	5h	8h	10h	20h
9.60V	142	109	65.3	40.2	23.8	17.1	13.7	11.7	8.02	6.62	3.51
9.90V	137	107	64.0	39.6	23.6	17.0	13.6	11.6	7.98	6.60	3.50
10.2V	132	103	62.1	38.6	23.4	16.9	13.5	11.5	7.92	6.58	3.49
10.5V	126	99.2	60.6	37.4	23.0	16.8	13.4	11.4	7.87	6.55	3.47
10.8V	119	93.9	58.3	36.2	22.5	16.3	13.0	11.1	7.63	6.50	3.45

Constant Power Discharge Characteristics Unit:W(25°C,77°F)

F.V/Time	10min	15min	30min	60min	2h	3h	4h	5h	8h	10h	20h
9.60V	1530	1199	733	458	275	201	161	138	95.3	79.0	42.1
9.90V	1484	1170	718	451	273	200	160	137	94.7	78.9	42.0
10.2V	1423	1127	696	440	271	199	159	136	94.1	78.6	41.9
10.5V	1362	1089	679	426	267	197	157	135	93.4	78.2	41.6
10.8V	1286	1031	655	412	260	191	153	131	90.6	77.6	41.3

Note: The above characteristics data can be obtained within three charge or discharge cycles.

NP12-65Ah 12V65Ah

● Discharge characteristics(25°C)

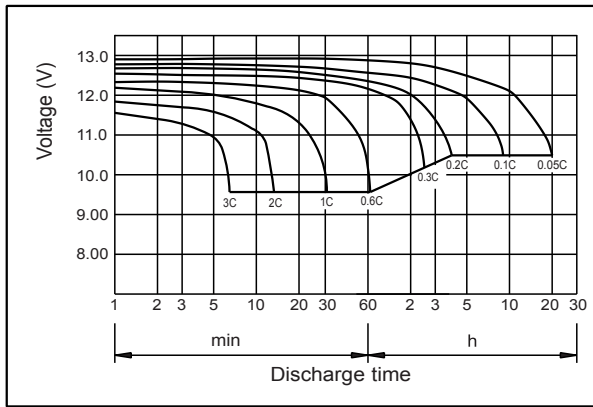

● Charging characteristics (25°C)

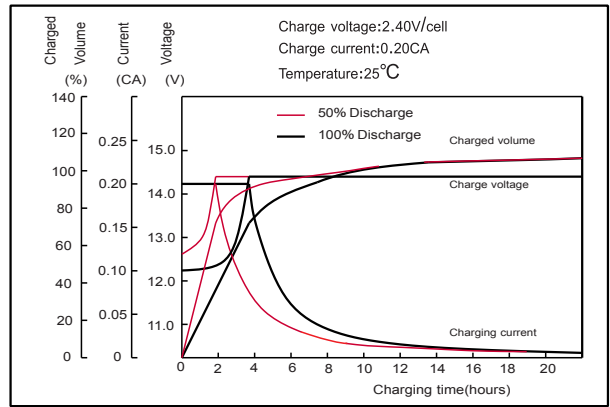

● Temperature effects on Capacity

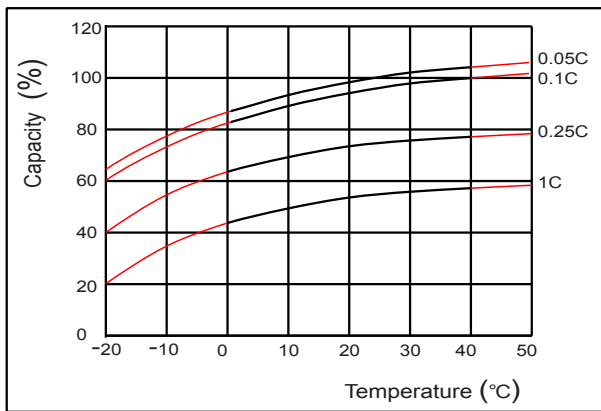

● Self-discharge characteristics

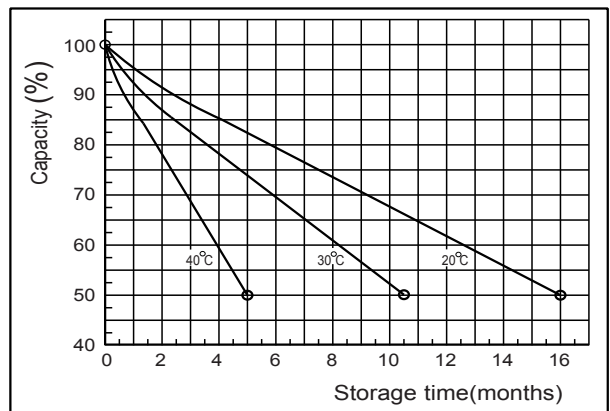

● Floating life on Temperature

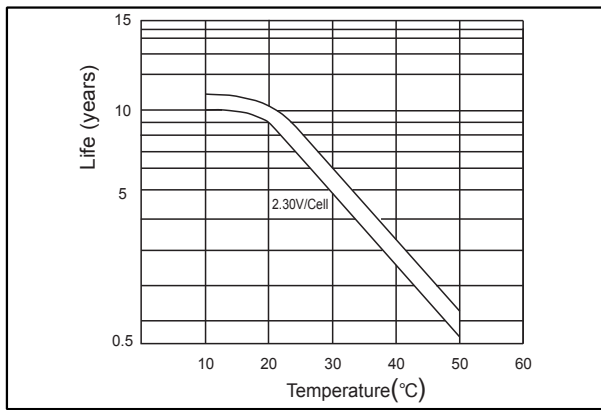

● Cycle life on D.O.D (25°C)

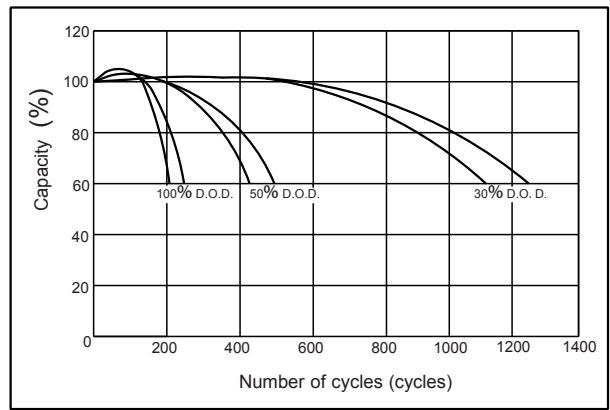

● The relationship for OCV and Capacity (25°C)

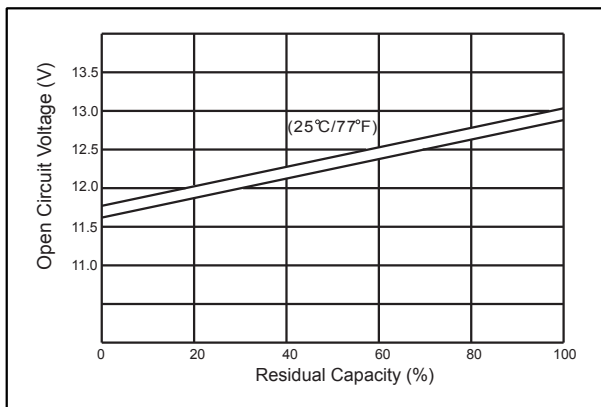

● The relationship for Charging voltage and Temperature

